



**F8A**  
**F9.9A**

## **OWNER'S MANUAL**

**⚠ Read this manual carefully before operating this outboard motor.**



**Read this manual carefully before operating this outboard motor. Keep this manual onboard in a waterproof bag when boating. This manual should stay with the outboard motor if it is sold.**

# Important manual information

## To the owner

Thank you for selecting a Outboards outboard motor. This Owner's Manual contains information needed for proper operation, maintenance and care. A thorough understanding of these simple instructions will help you obtain maximum enjoyment from your new Outboards. If you have any question about the operation or maintenance of your outboard motor, please consult a Outboards dealer.

In this Owner's Manual particularly important information is distinguished in the following ways.

: This is the safety alert symbol. It is used to alert you to potential personal injury hazards. Obey all safety messages that follow this symbol to avoid possible injury or death.

**A WARNING indicates a hazardous situation which, if not avoided, could result in death or serious injury.**

### **NOTICE**

**A NOTICE indicates special precautions that must be taken to avoid damage to the outboard motor or other property.**

### **TIP:**

A TIP provides key information to make procedures easier or clearer.

Outboards continually seeks advancements in product design and quality. Therefore, while this manual contains the most current product information available at the time of printing, there may be minor discrepancies between

your machine and this manual. If there is any question concerning this manual, please consult your Outboards dealer.

To ensure long product life, Outboards recommends that you use the product and perform the specified periodic inspections and maintenance by correctly following the instructions in the owner's manual. Any damage resulting from neglect of these instructions is not covered by warranty.

Some countries have laws or regulations restricting users from taking the product out of the country where it was purchased, and it may be impossible to register the product in the destination country. Additionally, the warranty may not apply in certain regions. When planning to take the product to another country, consult the dealer where the product was purchased for further information.

If the product was purchased used, please consult your closest dealer for customer re-registration, and to be eligible for the specified services.

### **TIP:**

The FPP8A, FPP9.9A, FPW8A, FPW9.9A and the standard accessories are used as a base for the explanations and illustrations in this manual. Therefore some items may not apply to every model.

**F8A, F9.9A**

**OWNER'S MANUAL**

**©2010 by Outboards Group CV**

**1st Edition, February 2015**

**All rights reserved.**

**Any reprinting or unauthorized use without the written permission of**

**Outboards Group CV**

**is expressly prohibited.**

**Printed in China**

# Table of contents

<b>Safety information.....</b>	<b>1</b>	Propeller selection .....	13
Outboard motor safety .....	1	Start-in-gear protection .....	14
Propeller .....	1	Engine oil requirements .....	14
Rotating parts .....	1	Fuel requirements .....	14
Hot parts.....	1	Gasoline .....	14
Electric shock .....	1	Muddy or acidic water .....	14
Power tilt.....	1	Anti-fouling paint .....	15
Engine shut-off cord (lanyard) .....	1	Motor disposal requirements.....	15
Gasoline .....	1	Emergency equipment .....	15
Gasoline exposure and spills .....	2	<b>Components .....</b>	<b>16</b>
Carbon monoxide .....	2	Components diagram.....	16
Modifications .....	2	Fuel tank.....	17
Boating safety .....	2	Fuel joint.....	18
Alcohol and drugs.....	2	Fuel gauge .....	18
Personal flotation devices .....	2	Fuel tank cap.....	18
People in the water.....	2	Air vent screw.....	18
Passengers .....	2	Remote control box .....	18
Overloading .....	2	Remote control lever .....	18
Avoid collisions.....	3	Neutral interlock trigger .....	19
Weather.....	3	Neutral throttle lever .....	19
Passenger training .....	3	Choke switch .....	19
Boating safety publications.....	3	Tiller handle.....	19
Laws and regulations .....	3	Gear shift lever .....	19
<b>General information .....</b>	<b>4</b>	Throttle grip .....	20
Identification numbers record .....	4	Throttle indicator.....	20
Outboard motor serial number .....	4	Throttle friction adjuster .....	20
Key number .....	4	Engine shut-off cord (lanyard) and clip.....	21
EC Declaration of Conformity (DoC).....	4	Engine stop button .....	22
CE Marking .....	5	Choke knob for pull type.....	22
Read manuals and labels.....	6	Manual starter handle.....	22
Warning labels.....	6	Main switch.....	22
<b>Specifications and requirements... 10</b>	<b>10</b>	Power tilt switch.....	23
Specifications .....	10	Steering friction adjuster.....	23
Installation requirements .....	12	Trim rod (tilt pin) .....	24
Boat horsepower rating .....	12	Tilt lock mechanism .....	24
Mounting motor .....	12	Tilt support knob.....	24
Remote control requirements .....	12	Tilt support bar .....	24
Battery requirements .....	13	Power tilt unit.....	25
Battery specifications .....	13	Cowling lock lever (pull up type).....	25
Mounting battery.....	13	Flushing device .....	25
		Alert indicator .....	25

# Table of contents

<b>Instruments and indicators</b> .....	<b>27</b>	Procedure.....	47
Indicators.....	27	Trimming outboard motor.....	47
Low oil pressure-alert indicator .....	27	Adjusting trim angle for manual tilt models .....	47
<b>Engine control system</b> .....	<b>28</b>	Adjusting trim angle (power tilt models) .....	48
Alert system .....	28	Adjusting boat trim.....	49
Low oil pressure alert .....	28	Tilting up and down.....	49
<b>Installation</b> .....	<b>29</b>	Procedure for tilting up (manual tilt models) .....	50
Installation .....	29	Procedure for tilting up (power tilt models) .....	51
Mounting the outboard motor .....	29	Procedure for tilting down (manual tilt models).....	52
Clamping the outboard motor.....	31	Procedure for tilting down (power tilt models) .....	52
<b>Operation</b> .....	<b>32</b>	Shallow water.....	52
First-time operation .....	32	Cruising in shallow water (manual tilt models).....	52
Fill engine oil .....	32	Power tilt models .....	54
Breaking in engine.....	32	Cruising in other conditions.....	55
Getting to know your boat .....	32	<b>Maintenance</b> .....	<b>56</b>
Checks before starting engine .....	32	Transporting and storing outboard motor.....	56
Fuel level .....	32	Dismounting the outboard motor .....	56
Remove the top cowling .....	33	Storing outboard motor.....	58
Fuel system .....	33	Procedure.....	58
Controls .....	33	Lubrication.....	59
Engine shut-off cord (lanyard) .....	33	Flushing power unit .....	59
Engine oil.....	34	Cleaning the outboard motor.....	60
Engine .....	34	Checking painted surface of outboard motor.....	60
Flushing device .....	34	Periodic maintenance .....	61
Install top cowling .....	35	Replacement parts .....	61
Checking power tilt system.....	35	Severe operating conditions.....	61
Battery .....	36	Maintenance chart 1.....	62
Filling fuel .....	36	Maintenance chart 2.....	64
Operating engine.....	37	Greasing.....	65
Sending fuel (portable tank) .....	37	Cleaning and adjusting spark plug ...	67
Starting engine .....	38	Checking fuel filter.....	67
Checks after starting engine .....	43	Inspecting idle speed.....	68
Cooling water .....	43	Changing engine oil.....	68
Warming up engine .....	43	Inspecting wiring and connectors .....	70
Manual start and electric start models .....	43	Checking propeller .....	70
Checks after engine warm up .....	44		
Shifting .....	44		
Stop switches .....	44		
Shifting .....	44		
Stopping boat .....	46		
Stopping engine .....	46		
Procedure.....	46		

# Table of contents

Removing propeller .....	71
Installing propeller .....	71
Changing gear oil .....	72
Cleaning fuel tank.....	73
Inspecting and replacing anode(s) ...	74
Checking battery (for electric start models) .....	75
Connecting the battery .....	75
Disconnecting the battery.....	76
<b>Trouble Recovery .....</b>	<b>77</b>
Troubleshooting .....	77
Temporary action in emergency....	80
Impact damage.....	80
Replacing fuse.....	80
Power tilt will not operate .....	81
Starter will not operate .....	81
Emergency starting engine.....	82
Engine fails to operate .....	83
Emergency engine operation .....	83
Treatment of submerged motor.....	83

## Outboard motor safety

Observe these precautions at all times.

### Propeller

People can be injured or killed if they come in contact with the propeller. The propeller can keep moving even when the motor is in neutral, and sharp edges of the propeller can cut even when stationary.

- Stop the engine when a person is in the water near you.
- Keep people out of reach of the propeller, even when the engine is off.

### Rotating parts

Hands, feet, hair, jewelry, clothing, PFD straps, etc. can become entangled with internal rotating parts of the engine, resulting in serious injury or death.

Keep the top cowling in place whenever possible. Do not remove or replace the cowling with the engine running.

Only operate the engine with the cowling removed according to the specific instructions in the manual. Keep hands, feet, hair, jewelry, clothing, PFD straps, etc. away from any exposed moving parts.

### Hot parts

During and after operation, engine parts are hot enough to cause burns. Avoid touching any parts under the top cowling until the engine has cooled.

### Electric shock

Do not touch any electrical parts while starting or operating the engine. They can cause shock or electrocution.

### Power tilt

Body parts can be crushed between the motor and the clamp bracket when the motor is trimmed or tilted. Keep body parts out of this area at all times. Be sure no one is in this area before operating the power tilt mechanism. The power tilt switches operate even when the main switch is off. Keep people away from the switches whenever working around the motor.

Never get under the lower unit while it is tilted, even when the tilt support lever or knob is locked. Severe injury could occur if the outboard motor accidentally falls.

### Engine shut-off cord (lanyard)

Attach the engine shut-off cord so that the engine stops if the operator falls overboard or leaves the helm. This prevents the boat from running away under power and leaving people stranded, or running over people or objects.

Always attach the engine shut-off cord to a secure place on your clothing or your arm or leg while operating. Do not remove it to leave the helm while the boat is moving. Do not attach the cord to clothing that could tear loose, or route the cord where it could become entangled, preventing it from functioning.

Do not route the cord where it is likely to be accidentally pulled out. If the cord is pulled during operation, the engine will shut off and you will lose most steering control. The boat could slow rapidly, throwing people and objects forward.

### Gasoline

**Gasoline and its vapors are highly flammable and explosive.** Always, refuel according to the procedure on page 37 to reduce the risk of fire and explosion.

# Safety information

## Gasoline exposure and spills

Take care not to spill gasoline. If gasoline spills, wipe it up immediately with dry rags.

Dispose of rags properly.

If any gasoline spills onto your skin, immediately wash with soap and water. Change clothing if gasoline spills on it.

If you swallow gasoline, inhale a lot of gasoline vapor, or get gasoline in your eyes, get immediate medical attention. Never siphon fuel by mouth.

## Carbon monoxide

This product emits exhaust gases which contain carbon monoxide, a colorless, odorless gas which may cause brain damage or death when inhaled. Symptoms include nausea, dizziness, and drowsiness. Keep cockpit and cabin areas well ventilated. Avoid blocking exhaust outlets.

## Modifications

Do not attempt to modify this outboard motor. Modifications to your outboard motor may reduce safety and reliability, and render the outboard unsafe or illegal to use.

## Boating safety

This section includes a few of the many important safety precautions that you should follow when boating.

## Alcohol and drugs

Never operate after drinking alcohol or taking drugs. Intoxication is one of the most common factors contributing to boating fatalities.

## Personal flotation devices

Have an approved personal flotation device (PFD) on board for every occupant. Outboards recommends that you must wear a PFD whenever boating. At a minimum, children and non-swimmers should always wear

PFDs, and everyone should wear PFDs when there are potentially hazardous boating conditions.

## People in the water

Always watch carefully for people in the water, such as swimmers, skiers, or divers, whenever the engine is running. When someone is in the water near the boat, shift into neutral and stop the engine.

Stay away from swimming areas. Swimmers can be hard to see.

The propeller can keep moving even when the motor is in neutral. Stop the engine when a person is in the water near you.

## Passengers

Consult your boat manufacturer's instructions for details about appropriate passenger locations in your boat and be sure all passengers are positioned properly before accelerating and when operating above an idle speed. Standing or sitting in non-designated locations may result in being thrown either overboard or within the boat due to waves, wakes, or sudden changes in speed or direction. Even when people are positioned properly, alert your passengers if you must make any unusual maneuver. Always avoid jumping waves or wakes.

## Overloading

Do not overload the boat. Consult the boat capacity plate or boat manufacturer for maximum weight and number of passengers. Be sure that weight is properly distributed according to the boat manufacturer's instructions. Overloading or incorrect weight distribution can compromise the boat's handling and lead to an accident, capsizing or swamping.



# Safety information

## Avoid collisions

Scan constantly for people, objects, and other boats. Be alert for conditions that limit your visibility or block your vision of others.

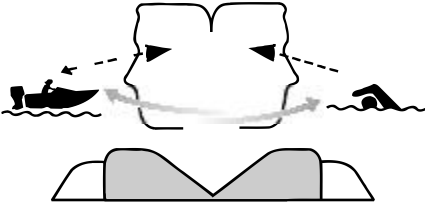

Operate defensively at safe speeds and keep a safe distance away from people, objects, and other boats.

- ⦿ Do not follow directly behind other boats or waterskiers.
- ⦿ Avoid sharp turns or other maneuvers that make it hard for others to avoid you or understand where you are going.
- ⦿ Avoid areas with submerged objects or shallow water.
- ⦿ Ride within your limits and avoid aggressive maneuvers to reduce the risk of loss of control, ejection, and collision.
- ⦿ Take early action to avoid collisions. Remember, boats do not have brakes, and stopping the engine or reducing throttle can reduce the ability to steer. If you are not sure that you can stop in time before hitting an obstacle, apply throttle and turn in another direction.

## Weather

Stay informed about the weather. Check weather forecasts before boating. Avoid boating in hazardous weather.

## Passenger training

Make sure at least one other passenger is trained to operate the boat in the event of an emergency.

## Boating safety publications

Be informed about boating safety. Additional publications and information can be obtained from many boating organizations.

## Laws and regulations

Know the marine laws and regulations where you will be boating- and obey them. Several sets of rules prevail according to geographic location, but all are basically the same as the International Rules of the Road.

# General information

## Identification numbers record

### Outboard motor serial number

The outboard motor serial number is stamped on the label attached to the port side of the clamp bracket.

Record your outboard motor serial number in the spaces provided to assist you in ordering spare parts from your Outboards dealer or for reference in case your outboard motor is stolen.

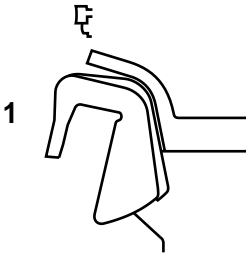

1. Outboard motor serial number location

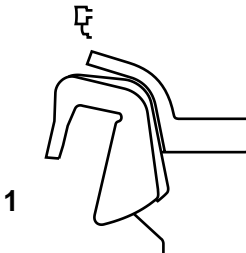

1. Outboard motor serial number location

### Key number

If a main key switch is equipped with the motor, the key identification number is stamped on your key as shown in the illustration. Record this number in the space provided for reference in case you need a new key.

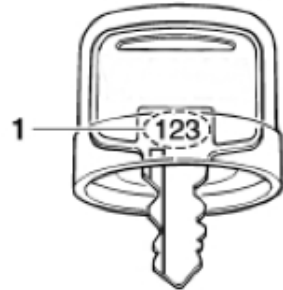

1. Key number

## EC Declaration of Conformity (DoC)

This outboard motor conforms to certain portions of the European Parliament directive relating to machinery.

Each conformed outboard motor accompanied with EC DoC. EC DoC contains the following information;

- ρ Name of Engine Manufacture
- ρ Model name

# General information

- ∅ Product code of model (Approved model code)
- ∅ Code of conformed directives

## CE Marking

Outboard motors affixed with this “CE” marking conform with the directives of; 98/37/EC, 94/25/EC - 2003/44/EC and 2004/108/EC.

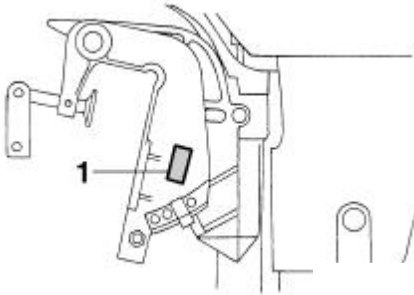

1. CE marking location

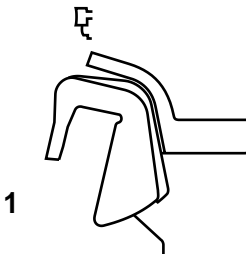

1. CE marking location

# General information

## Read manuals and labels

Before operating or working on this outboard motor:

- ⦿ Read this manual.
  - ⦿ Read any manuals supplied with the boat.
  - ⦿ Read all labels on the outboard motor and the boat.
- If you need any additional information, contact your Outboards dealer.

## Warning labels

If these labels are damaged or missing, contact your Outboards dealer for replacements.

**FPP8AMH, FPP9.9AMH, FPW8AMH, FPW9.9AMH**

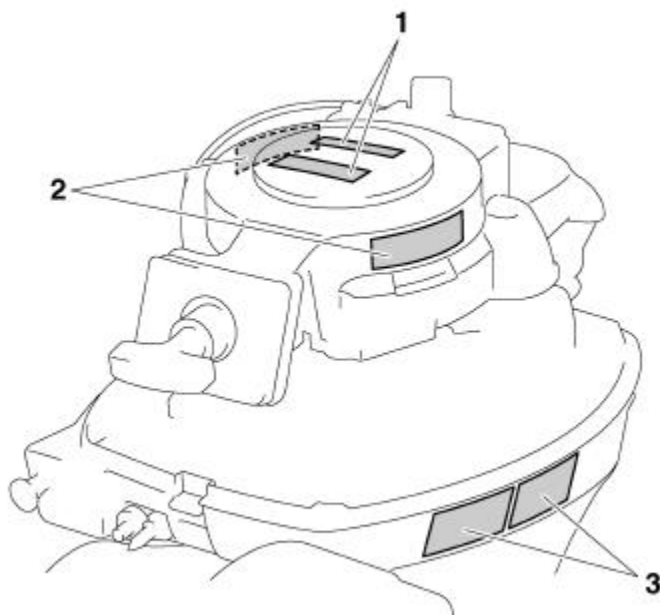

# General information

FPP8AER, FPP9.9AER, FPW8AER, FPW9.9AER

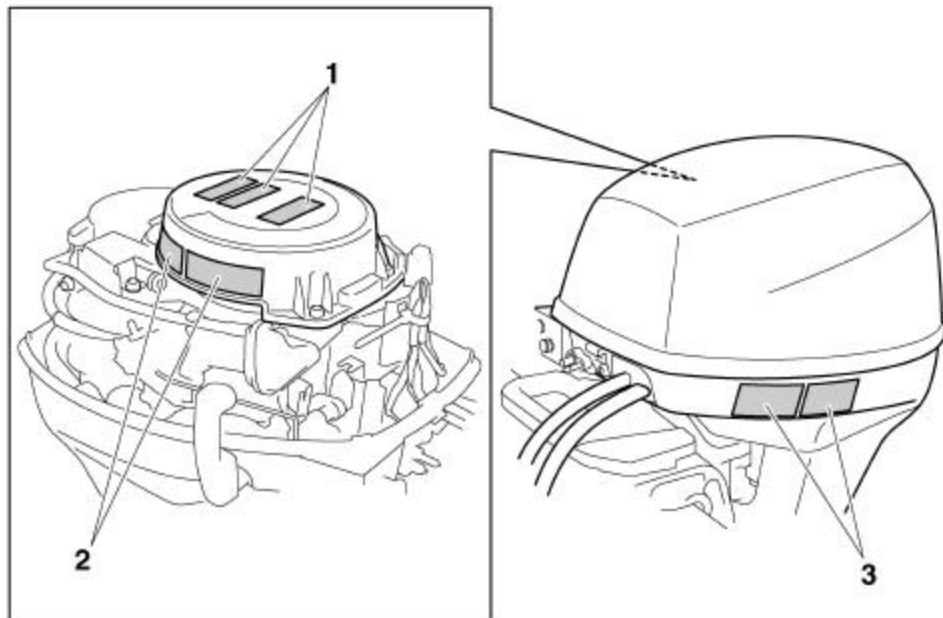

# General information

1



2



3

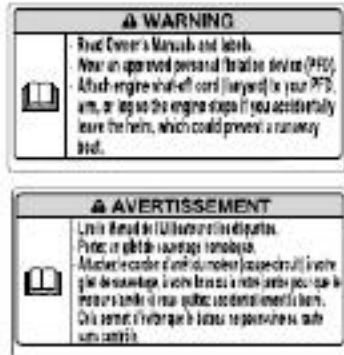

## Contents of labels

The above warning labels mean as follows.

1

**⚠ WARNING**  
Emergency starting does not have start-in-gear protection. Ensure shift control is in neutral before starting engine.

2

**⚠ WARNING**  
Keep hands, hair, and clothing away from rotating parts while the engine is running.  
Do not touch or remove electrical parts when starting or during operation.

3

**⚠ WARNING**  
Read Owner's Manuals and labels.  
Wear an approved personal flotation device (PFD).  
Attach engine shut-off cord (lanyard) to your PFD, arm, or leg so the engine stops if you accidentally leave the helm, which could prevent a runaway boat.

# General information

## Symbols

The following symbols mean as follows.

Notice/Warning



Electrical hazard

Remote control lever/gear shift lever operating direction, dual direction

Read Owner's Manual



Engine start/ Engine cranking

Hazard caused by continuous rotation



# Specifications and requirements

## Specifications

### TIP:

“(AL)” stated in the specification data below represents the numerical value for the aluminum propeller installed.

Likewise, “(SUS)” represents the value for stainless steel propeller installed and “(PL)” for plastic propeller installed.

### TIP:

“\*\*” means, select the engine oil referring to the chart of engine oil paragraph. For further information, see page 14.

### Dimension:

#### Overall length:

FPP(8/9.9)AER	552 mm (21.7 in)
FPW(8/9.9)AER	552 mm (21.7 in)
FPP8AMH	927 mm (36.5 in)
FPP9.9AMH	927 mm (36.5 in)
FPW8AMH	1038 mm (40.9 in)
FPW9.9AMH	1038 mm (40.9 in)

#### Overall width:

FPP(8/9.9)AER	332 mm (13.1 in)
FPW(8/9.9)AER	332 mm (13.1 in)
FPP8AMH	375 mm (14.8 in)
FPP9.9AMH	375 mm (14.8 in)
FPW8AMH	370 mm (14.6 in)
FPW9.9AMH	370 mm (14.6 in)

#### Overall height S:

FPP(8/9.9)AER	1000 mm (39.4 in)
FPP(8/9.9)AMH	1000 mm (39.4 in)

#### Overall height L:

FPP(8/9.9)AER	1127 mm (44.4 in)
FPP(8/9.9)AMH	1127 mm (44.4 in)
FPW(8/9.9)AER	1187 mm (46.7 in)
FPW(8/9.9)AMH	1187 mm (46.7 in)

#### Overall height X:

FPW(8/9.9)AER	1255 mm (49.4 in)
FPW(8/9.9)AMH	1255 mm (49.4 in)

#### Transom height S:

FPP(8/9.9)AER	430 mm (16.9 in)
FPP(8/9.9)AMH	435 mm (17.1 in)

#### Transom height L:

FPP(8/9.9)AER	557 mm (21.9 in)
FPP(8/9.9)AMH	557 mm (21.9 in)
FPW(8/9.9)AER	557 mm (21.9 in)
FPW(8/9.9)AMH	552 mm (21.7 in)

#### Transom height X:

FPW(8/9.9)AER	625 mm (24.6 in)
FPW(8/9.9)AMH	620 mm (24.4 in)

#### Weight (AL) S:

FPP(8/9.9)AER	42.0 kg (93 lb)
FPP(8/9.9)AMH	40.0 kg (88 lb)

#### Weight (AL) L:

FPP(8/9.9)AER	43.0 kg (95 lb)
FPP(8/9.9)AMH	41.0 kg (90 lb)
FPW(8/9.9)AER	44.0 kg (97 lb)
FPW(8/9.9)AMH	46.0 kg (101 lb)

#### Weight (AL) X:

FPW(8/9.9)AER	45.0 kg (99 lb)
FPW(8/9.9)AMH	47.0 kg (104 lb)

### Performance:

#### Full throttle operating range:

5000–6000 r/min

#### Maximum output:

7.3 kW@5500 r/min (9.9 HP@5500 r/min)

5.9 Kw@5500 r/min (8 HP@5500 r/min)

#### Idle speed (in neutral):

1050 ±50 r/min

### Engine:

#### Type:

4-stroke L

#### Displacement:

212.0 cm<sup>3</sup>

#### Bore · stroke:

56.0 · 43.0 mm (2.20 · 1.69 in)

#### Ignition system:

CDI



# Specifications and requirements

## Spark plug (NGK):

BR6HS-10

## Spark plug gap:

0.9–1.0 mm (0.035–0.039 in)

## Control system:

FPP(8/9.9)AER Remote control

FPP(8/9.9)AMH Tiller handle

FPW(8/9.9)AER Remote control

FPW(8/9.9)AMH Tiller handle

## Starting system:

FPP(8/9.9)AER Electric starter

FPP(8/9.9)AMH Manual starter

FPW(8/9.9)AER Electric starter

FPW(8/9.9)AMH Manual starter

## Starting carburetion system:

Choke valve

## Valve clearance (cold engine) IN:

0.15–0.20 mm (0.0059–0.0079 in)

## Valve clearance (cold engine) EX:

0.20–0.25 mm (0.0079–0.0098 in)

## Min. cold cranking amps (CCA/EN):

FPP(8/9.9)AER 347.0 A

FPW(8/9.9)AER 347.0 A

## Min. rated capacity (20HR/IEC):

FPP(8/9.9)AER 40.0 Ah

FPW(8/9.9)AER 40.0 Ah

## Alternator output:

FPP(8/9.9)AMH 80 W

FPW(8/9.9)AMH 80 W

## Maximum generator output:

FPP(8/9.9)AER 6 A

FPW(8/9.9)AER 6 A

## Drive unit:

### Gear positions:

Forward-neutral-reverse

## Gear ratio:

FPP(8/9.9)AER 2.08(27/13)

FPP(8/9.9)AMH 2.08(27/13)

FPW(8/9.9)AER 2.92(38/13)

FPW(8/9.9)AMH 2.92(38/13)

## Trim and tilt system:

FPP(8/9.9)AER Manual tilt

FPP(8/9.9)AMH Manual tilt

FPW(8/9.9)AER Manual tilt

FPW(8/9.9)AMH Manual tilt

## Propeller mark:

FPP(8/9.9)AER N

FPP(8/9.9)AMH N

FPW(8/9.9)AER R

FPW(8/9.9)AMH R

## Fuel and oil:

### Recommended fuel:

Regular unleaded gasoline

### Min. research octane:

90

### Fuel tank capacity:

12.0 L (3.17 US gal, 2.64 Imp.gal)

### Recommended engine oil:

4-stroke outboard motor oil

### Recommended engine oil group 1\*:

SAE 10W-30/10W-40/5W-30

API SE/SF/SG/SH/SJ/SL

### Recommended engine oil group 2\*:

SAE 15W-40/20W-40/20W-50

API SH/SJ/SL

### Engine oil quantity:

0.8 L (0.85 US qt, 0.70 Imp.qt)

### Lubrication:

Wet sump

### Recommended gear oil:

Hypoid gear oil SAE#90

# Specifications and requirements

Gear oil quantity:

FPP(8/9.9)AER 0.150 L (0.159 US qt,  
0.132 Imp.qt)

FPP(8/9.9)AMH 0.150 L (0.159 US qt,  
0.132 Imp.qt)

FPW(8/9.9)AER 0.370 L (0.391 US qt,  
0.326 Imp.qt)

FPW(8/9.9)AMH 0.370 L (0.391 US qt,  
0.326 Imp.qt)

## Tightening torque for engine:

Spark plug:

25.0 Nm (2.55 kgf-m, 18.4 ft-lb)

Propeller nut:

FPP(8/9.9)AER 17.0 Nm (1.73 kgf-m,  
12.5 ft-lb)

FPP(8/9.9)AMH 17.0 Nm (1.73 kgf-m,  
12.5 ft-lb)

FPW(8/9.9)AER 21.0 Nm (2.14 kgf-m,  
15.5 ft-lb)

FPW(8/9.9)AMH 21.0 Nm (2.14 kgf-m,  
15.5 ft-lb)

Engine oil drain bolt:

24.0 Nm (2.45 kgf-m, 17.7 ft-lb)

## Noise and vibration level:

Operator sound pressure level (ICOMIA  
39/94 and 40/94):

78.2 dB(A)

Vibration on tiller handle (ICOMIA 38/94):

FPP(8/9.9)AMH Vibration on tiller handle is  
under 2.5 m/s<sup>2</sup>

FPW(8/9.9)AMH Vibration on tiller handle is  
under 2.5 m/s<sup>2</sup>

## Installation requirements

### Boat horsepower rating

**Overpowering a boat can cause severe instability.**

Before installing the outboard motor(s), confirm that the total horsepower of your outboard motor(s) does not exceed the boat's maximum horsepower rating. See the boat's capacity plate or contact the manufacturer.

### Mounting motor

⚠ **Improper mounting of the outboard motor could result in hazardous conditions such as poor handling, loss of control, or fire hazards.**

⚠ **Because the motor is very heavy, special equipment and training is required to mount it safely.**

Your dealer or other person experienced in proper rigging should mount the motor using correct equipment and complete rigging instructions. For further information, see page 29.

## Remote control requirements

⚠ **If the engine starts in gear, the boat can move suddenly and unexpectedly, possibly causing a collision or throwing passengers overboard.**

⚠ **If the engine ever starts in gear, the start-in-gear protection device is not working correctly and you should discontinue using the outboard. Contact your Outboards dealer.**

# Specifications and requirements

The remote control unit must be equipped with a start-in-gear protection device(s). This device prevents the engine from starting unless it is in neutral.

## Battery requirements

### Battery specifications

Minimum cold cranking amps (CCA/EN):  
FPP(8/9.9)AER 347.0 A  
FPW(8/9.9)AER 347.0 A

Minimum rated capacity (20HR/IEC):  
FPP(8/9.9)AER 40.0 Ah  
FPW(8/9.9)AER 40.0 Ah

The engine cannot be started if battery voltage is too low.

### Mounting battery

Mount the battery holder securely in a dry, well-ventilated, vibration-free location in the boat. **WARNING! Do not put flammable items, or loose heavy or metal objects in the same compartment as the battery. Fire, explosion or sparks could result.**

## Propeller selection

Next to selecting an outboard motor, selecting the right propeller is one of the most important purchasing decisions a boater can make. The type, size, and design of your propeller have a direct impact on acceleration, top speed, fuel economy, and even engine life. Outboards designs and manufactures propellers for every Outboards outboard motor and every application.

Your outboard motor came with a Outboards propeller selected to perform well over a range of applications, but there may be uses where a different propeller would be more appropriate.

Your Outboards dealer can help you select the right propeller for your boating needs. Select a propeller that will allow the engine to reach the middle or upper half of the operating range at full throttle with the maximum boat-load. Generally, select a larger pitch propeller for a smaller operating load and a smaller pitch propeller for a heavier load. If you carry loads that vary widely, select the propeller that lets the engine run in the proper range for your maximum load but remember that you may need to reduce your throttle setting to stay within the recommended engine speed range when carrying lighter loads.

To check the propeller, see page 70.

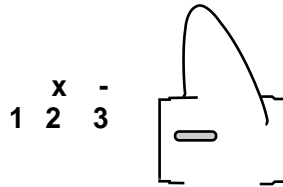

1. Propeller diameter in inches
2. Propeller pitch in inches
3. Type of propeller (propeller mark)

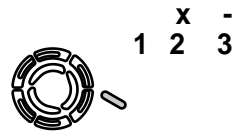

1. Propeller diameter in inches
2. Propeller pitch in inches
3. Type of propeller (propeller mark)

# Specifications and requirements

## Start-in-gear protection

Outboards outboard motors affixed with the pictured label or Outboards-approved remote control units are equipped with start-in-gear protection device(s). This feature permits the engine to be started only when it is in neutral. Always select neutral before starting the engine.

1



1. Start-in-gear protection label

## Engine oil requirements

Recommended engine oil:

4-stroke motor oil with a combination of the following SAE and API oil classifications

Engine oil type SAE:

10W-30 or 10W-40

Engine oil grade API:

SE, SF, SG, SH, SJ, SL

Engine oil quantity:

0.8 L (0.85 US qt, 0.70 Imp.qt)

If the recommended engine oil grades are not available, select an alternative from the following chart according to the average temperatures in your area.

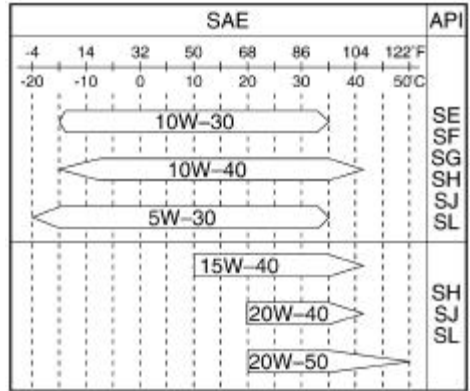

## Fuel requirements

### Gasoline

Use a good quality gasoline that meets the minimum octane rating. If knocking or pinging occurs, use a different brand of gasoline or premium unleaded fuel.

Recommended gasoline:

Regular unleaded gasoline with a minimum octane rating of 90 (Research Octane Number).

### NOTICE

- Do not use leaded gasoline. Leaded gasoline can seriously damage the engine.
- Avoid getting water and contaminants in the fuel tank. Contaminated fuel can cause poor performance or engine damage. Use only fresh gasoline that has been stored in clean containers.

### Muddy or acidic water

Outboards strongly recommends that you have your dealer install the optional chromium-plated water pump kit if you use the outboard mo-

# Specifications and requirements

tor in muddy or acidic water conditions. However, depending on the model it might not be required.

## Anti-fouling paint

A clean hull improves boat performance. The boat bottom should be kept as clean of marine growth as possible. If necessary, the boat bottom can be coated with an anti-fouling paint approved for your area to inhibit marine growth.

Do not use anti-fouling paint which includes copper or graphite. These paints can cause more rapid engine corrosion.

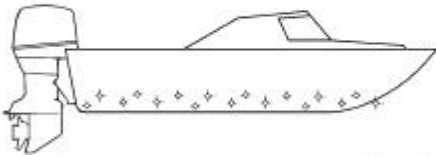

## Motor disposal requirements

Never illegally discard (dump) the motor. Outboards recommends consulting the dealer about discarding the motor.

## Emergency equipment

Keep the following items onboard in case there is trouble with the outboard motor.

- ⦿ A tool kit with assorted screwdrivers, pliers, wrenches (including metric sizes), and electrical tape.
- ⦿ Waterproof flashlight with extra batteries.
- ⦿ An extra engine shut-off cord (lanyard) with clip.
- ⦿ Spare parts, such as an extra set of spark plugs.

Consult your Outboards dealer for details.

# Components

## Components diagram

### TIP:

\* May not be exactly as shown; also may not be included as standard equipment on all models (order from dealer).

**FPP8A; FPP9.9A**

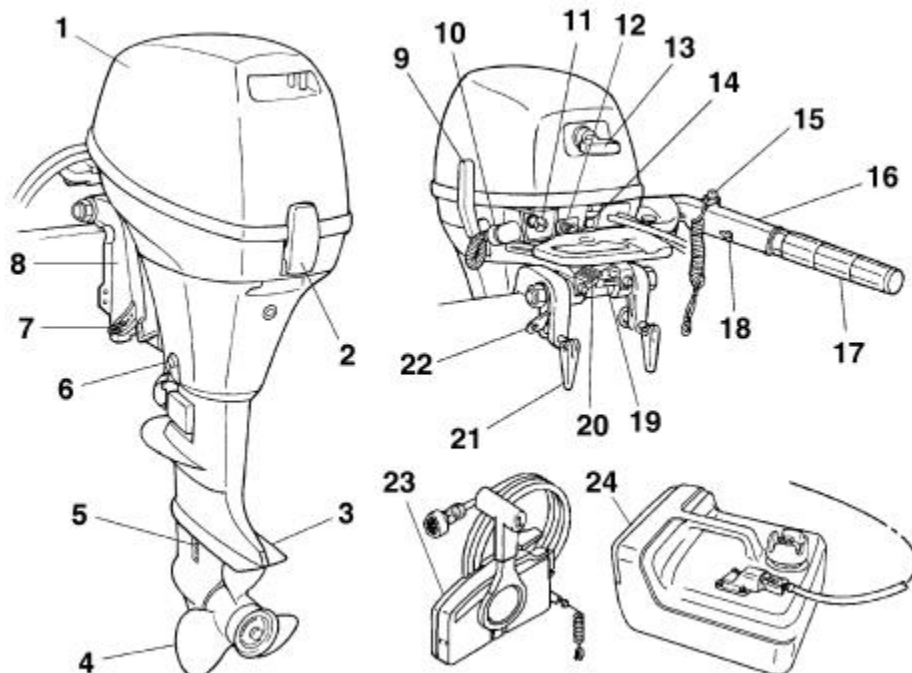

1. Top cowling
2. Cowling lock lever
3. Anti-cavitation plate
4. Propeller
5. Cooling water inlet
6. Drain screw
7. Trim rod
8. Clamp bracket
9. Gear shift lever\*
10. Flushing device
11. Choke knob
12. Fuel joint
13. Manual starter handle\*
14. Alert indicator
15. Engine stop button/Engine shut-off switch\*

16. Tiller handle\*
17. Throttle grip\*
18. Throttle friction adjuster\*
19. Tilt lock lever
20. Steering friction adjuster\*
21. Clamp screw
22. Restraint cable attachment
23. Remote control box (side mount type)\*
24. Fuel tank

# Components

FPP8A; FPP9.9A

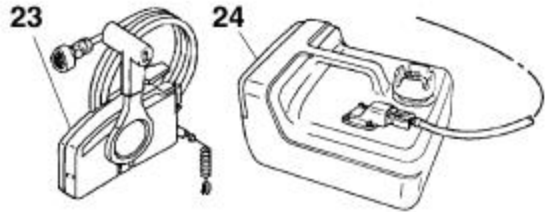
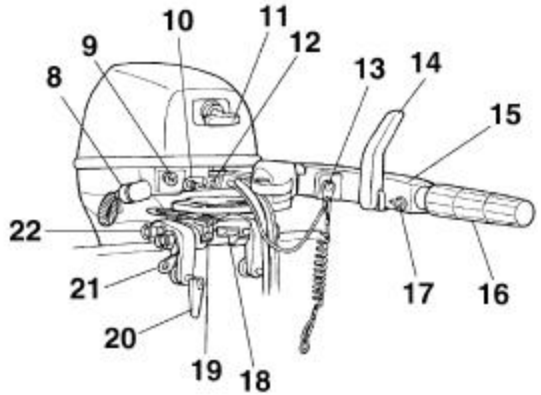
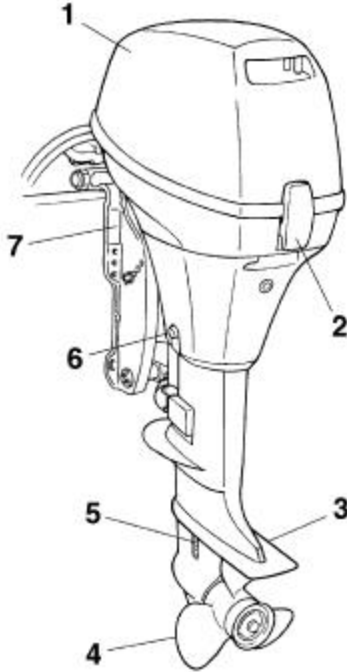

1. Top cowling
2. Cowling lock lever
3. Anti-cavitation plate
4. Propeller
5. Cooling water inlet
6. Drain screw
7. Clamp bracket
8. Flushing device
9. Choke knob
10. Fuel joint
11. Manual starter handle\*
12. Alert indicator
13. Engine stop button/Engine shut-off switch\*
14. Gear shift lever\*
15. Tiller handle\*
16. Throttle grip\*
17. Throttle friction adjuster\*
18. Tilt lock lever\*
19. Steering friction adjuster\*
20. Clamp screw
21. Restraint cable attachment

22. Tilt support knob\*
23. Remote control box (side mount type)\*
24. Fuel tank

## Fuel tank

If your model was equipped with a portable fuel tank, its function is as follows.

**The fuel tank supplied with this engine is its dedicated fuel reservoir and must not be used as a fuel storage container. Commercial users should conform to relevant licensing or approval authority regulations.**

# Components

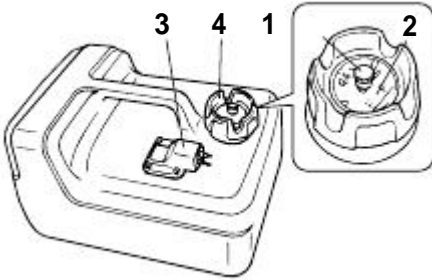

1. Air vent screw
2. Fuel gauge
3. Fuel joint
4. Fuel tank cap

## Fuel joint

This joint is used to connect the fuel line.

## Fuel gauge

This gauge is located on either the fuel tank cap or on the fuel joint base. It shows the approximate amount of fuel remaining in the tank.

## Fuel tank cap

This cap seals the fuel tank. When removed, the tank can be filled with fuel. To remove the cap, turn it counterclockwise.

## Air vent screw

This screw is on the fuel tank cap. To loosen the screw, turn it counterclockwise.

## Remote control box

The remote control lever actuates both the shifter and the throttle. The electrical switches are mounted on the remote control box.

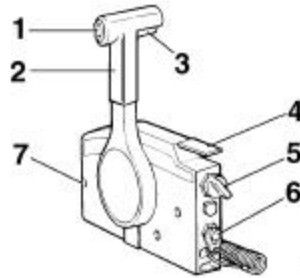

1. Power tilt switch
2. Remote control lever
3. Neutral interlock trigger
4. Neutral throttle lever
5. Main switch / choke switch
6. Engine shut-off switch
7. Throttle friction adjuster

## Remote control lever

Moving the lever forward from the neutral position engages forward gear. Pulling the lever back from neutral engages reverse. The engine will continue to run at idle until the lever is moved about 35° (a detent can be felt). Moving the lever farther opens the throttle, and the engine will begin to accelerate.

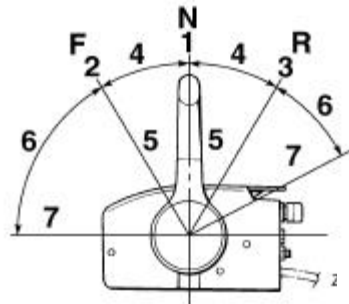

1. Neutral " N "
2. Forward " F "
3. Reverse " R "
4. Shift
5. Fully closed
6. Throttle
7. Fully open



# Components

## Neutral interlock trigger

To shift out of neutral, first pull the neutral interlock trigger up.

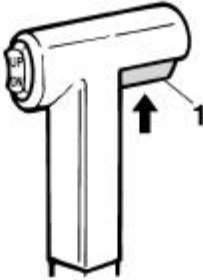

1. Neutral interlock trigger

## Neutral throttle lever

To open the throttle without shifting into either forward or reverse, put the remote control lever in the neutral position and lift the neutral throttle lever.

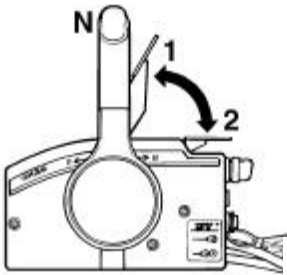

1. Fully open
2. Fully closed

### TIP:

The neutral throttle lever will operate only when the remote control lever is in neutral. The remote control lever will operate only when the neutral throttle lever is in the closed position.

## Choke switch

To activate the choke system, press in the main switch while the key is turned to the “ ” (on) or “S ‘AR’ ” (start) position. The choke system will then supply the rich fuel mixture required to start the engine. When the key is released, the choke will switch off automatically.

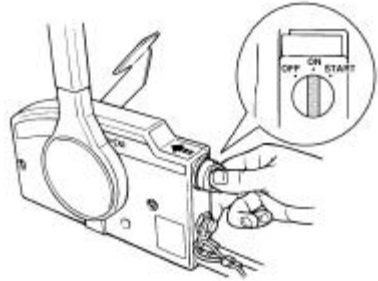

## Tiller handle

To change direction, move the tiller handle to the left or right as necessary.



## Gear shift lever

Move the gear shift lever forward to engage the forward gear or rearward to engage the reverse gear.

# Components

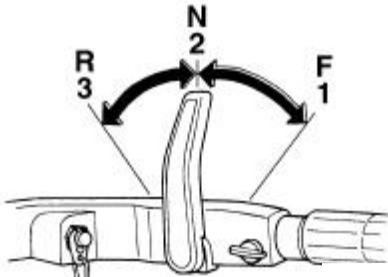

1. Forward " F 1 "
2. Neutral " N 2 "
3. Reverse " R 3 "

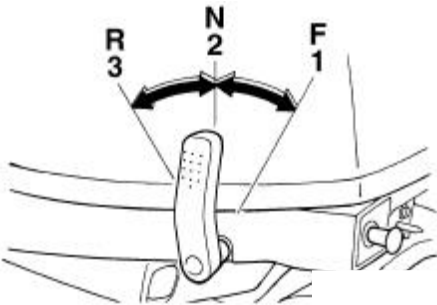

1. Forward " F 1 "
2. Neutral " N 2 "
3. Reverse " R 3 "

## Throttle grip

The throttle grip is on the tiller handle. Turn the grip counterclockwise to increase speed and clockwise to decrease speed.

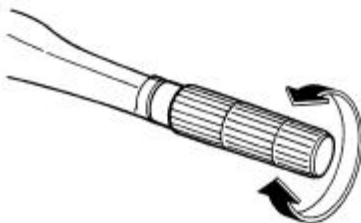

## Throttle indicator

The fuel consumption curve on the throttle indicator shows the relative amount of fuel consumed for each throttle position. Choose the setting that offers the best performance and fuel economy for the desired operation.

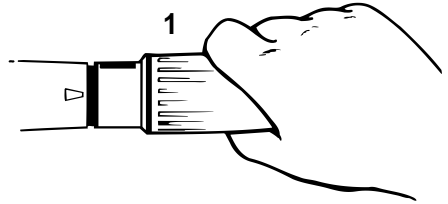

1. Throttle indicator

## Throttle friction adjuster

A friction device provides adjustable resistance to movement of the throttle grip or the remote control lever, and can be set according to operator preference.

To increase resistance, turn the adjuster clockwise. To decrease resistance, turn the adjuster counterclockwise. **WARNING! Do not overtighten the friction adjuster. If there is too much resistance, it could be difficult to move the remote control lever or throttle grip, which could result in an accident.**

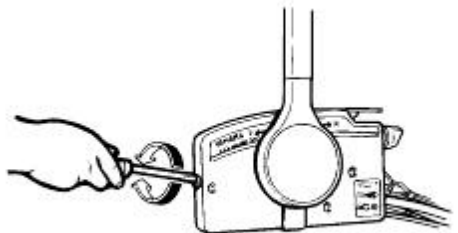

# Components

the loss of most steering control. Also, without engine power, the boat could slow rapidly. This could cause people and objects in the boat to be thrown forward.

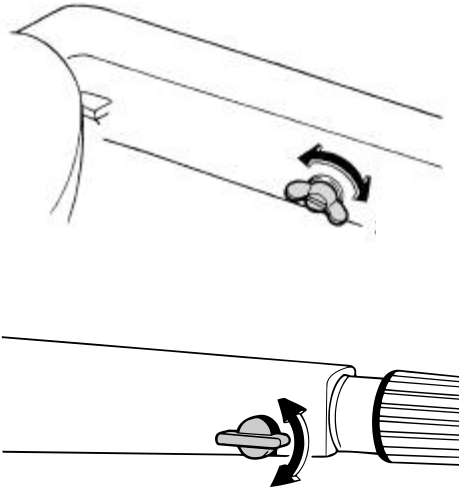

When constant speed is desired, tighten the adjuster to maintain the desired throttle setting.

## Engine shut-off cord (lanyard) and clip

The clip must be attached to the engine shut-off switch for the engine to run. The cord should be attached to a secure place on the operator's clothing, or arm or leg. Should the operator fall overboard or leave the helm, the cord will pull out the clip, stopping ignition to the engine. This will prevent the boat from running away under power. **WARNING! Attach the engine shut-off cord to a secure place on your clothing, or your arm or leg while operating. Do not attach the cord to clothing that could tear loose. Do not route the cord where it could become entangled, preventing it from functioning. Avoid accidentally pulling the cord during normal operation. Loss of engine power means**

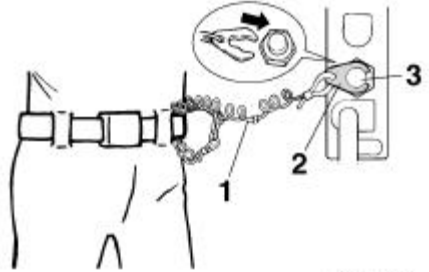

ZMU01716

1. Cord
2. Clip
3. Engine shut-off switch

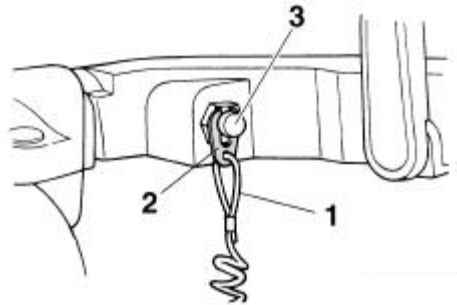

1. Cord
2. Clip
3. Engine shut-off switch

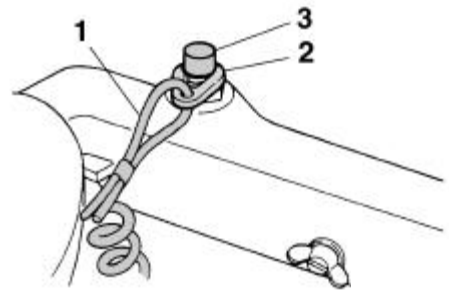

1. Cord

# Components

- 2. Clip
- 3. Engine shut-off switch

## Engine stop button

The engine stop button stops the engine when the button is pushed.

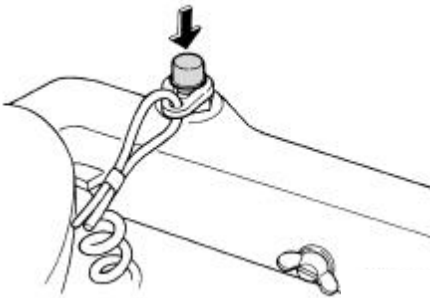
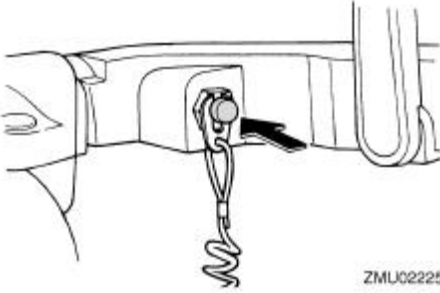

## Choke knob for pull type

To supply the engine with the rich fuel mixture required to start, pull out this knob.

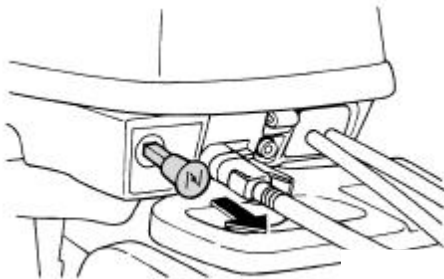

## Manual starter handle

The manual starter handle is used to crank and start the engine.

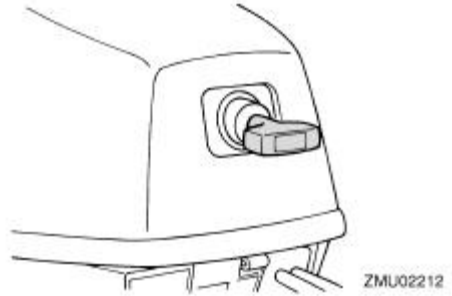

## Main switch

The main switch controls the ignition system; its operation is described below.

### ⌚ "o" (off)

With the main switch in the "o" (off) position, the electrical circuits are off, and the key can be removed.

### ⌚ "o" (on)

With the main switch in the "o" (on) position, the electrical circuits are on, and the key cannot be removed.

### ⌚ "s 'AR" (start)

With the main switch in the "s 'AR" (start) position, the starter motor turns to start the engine. When the key is released, it returns automatically to the "o" (on) position.

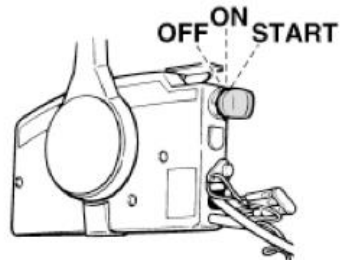

# Components

## Power tilt switch

The power tilt system adjusts the outboard motor angle in relation to the transom. Pushing the switch “UP” (up) tilts the outboard motor up. Pressing the switch “DN” (down) tilts the outboard motor down. When the switch is released, the outboard motor will stop in its current position.



### TIP:

For instructions on using the power tilt switch, see pages 47 and 49.

## Steering friction adjuster

A friction device provides adjustable resistance to the steering mechanism, and can be set according to operator preference. An adjuster lever is located on the bottom of the tiller handle bracket.

To increase resistance, turn the lever to the port side “A”.

To decrease resistance, turn the lever to the starboard side “B”.

**Do not overtighten the friction adjuster. If there is too much resistance, it could be difficult to steer, which could result in an accident.**

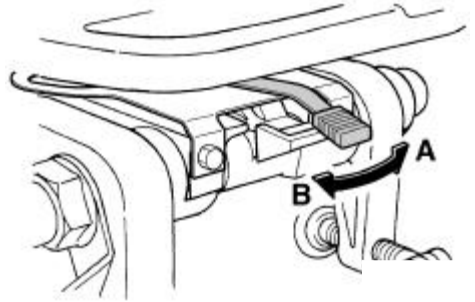

If the resistance does not increase even when the lever is turned to the port side “A”, make sure that the nut is tightened to the specified torque.

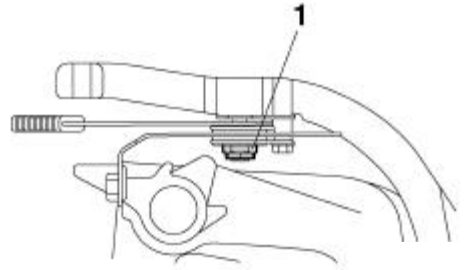

1. Nut

Nut tightening torque:  
6.0 Nm (0.61 kgf-m, 4.4 ft-lb)

### TIP:

- Steering movement is blocked when the adjuster lever is set to the “A” position.
- Check the tiller handle for smooth movement when the lever is turned to the starboard side “B”.
- Do not apply lubricants such as grease to the friction areas of the steering friction adjuster.

# Components

## Trim rod (tilt pin)

The position of the trim rod determines the minimum trim angle of the outboard motor in relation to the transom.

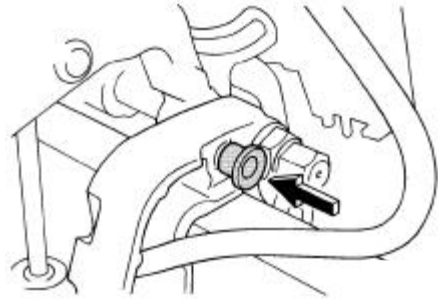
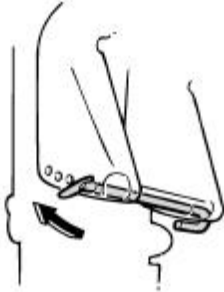

## NOTICE

Do not use the tilt support lever or knob when trailering the boat. The outboard motor could shake loose from the tilt support and fall. If the motor cannot be trailered in the normal running position, use an additional support device to secure it in the tilt position.

## Tilt lock mechanism

The tilt lock mechanism is used to prevent the outboard motor from lifting out of the water when in reverse gear.

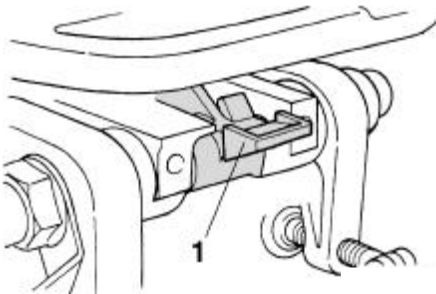

1. Tilt lock lever

To lock it, set the tilt lock lever in the lock position. To release, push the tilt lock lever in the release position.

## Tilt support knob

To keep the outboard motor in the tilted up position, push the tilt support knob under the swivel bracket.

## Tilt support bar

The tilt support bar keeps the outboard motor in the tilted up position.

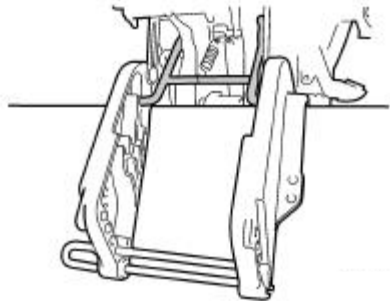

## NOTICE

Do not use the tilt support bar when trailering the boat. The outboard motor could shake loose from the tilt support and fall. If the motor cannot be trailered

# Components

mal running position, use an additional support device to secure it in the tilt position.

## Power tilt unit

This unit tilts the outboard motor up and down and is controlled with the power tilt switch.

### NOTICE

Do not step on or exert pressure on the power tilt motor. The power tilt unit could be damaged as a result.

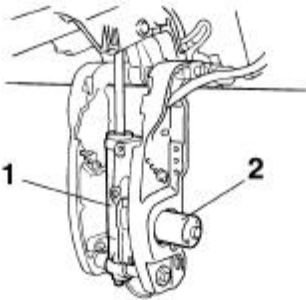

1. Power tilt unit
2. Power tilt motor

### NOTICE

Do not use the tilt support lever or knob when trailering the boat. The outboard motor could shake loose from the tilt support and fall. If the motor cannot be trailered in the normal running position, use an additional support device to secure it in the tilt position.

## Cowling lock lever (pull up type)

To remove the engine top cowling, pull up the cowling lock lever(s) and lift off the cowling. When installing the cowling, check to be sure it fits properly in the rubber seal. Then lock the cowling by moving the cowling lock lever(s) downward.

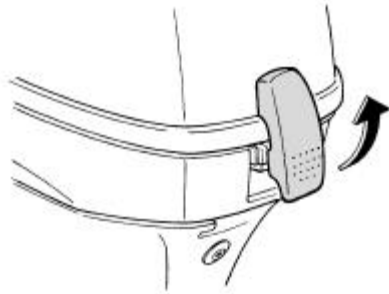

## Flushing device

This device is used to clean the cooling water passages of the motor using a garden hose and tap water.

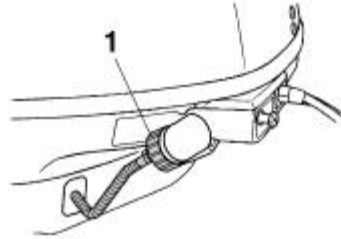

1. Flushing device

### TIP:

For details on usage, see page 59.

## Alert indicator

If the engine develops a condition which is cause for alert, the indicator lights up. For details on how to read the alert indicator, see page 28.

# Components

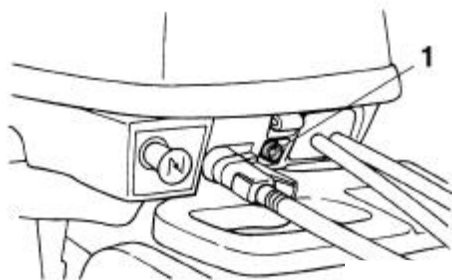

1. Low oil pressure-alert indicator



## Indicators

### Low oil pressure-alert indicator

If oil pressure drops too low, this indicator will light up. For further information, see page 28.

#### **NOTICE**

- ⚠ **Do not continue to run the engine if the low oil pressure-alert indicator is on and the engine oil level is lower. Serious engine damage will occur.**
- ⚠ **The low oil pressure-alert indicator does not indicate the engine oil level. Use the oil dipstick to check the remaining oil quantity. For further information, see page 34.**

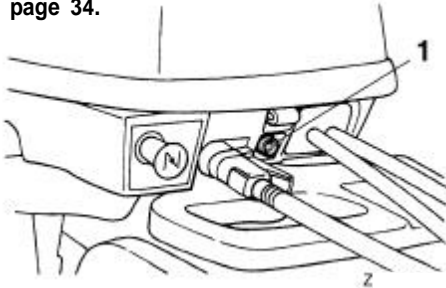

1. Low oil pressure-alert indicator

# Engine control system

## Alert system

### **NOTICE**

Do not continue to operate the engine if a alert device has activated. Consult your Outboards dealer if the problem cannot be located and corrected.

### **Low oil pressure alert**

If the oil pressure drops too low, the alert device will activate.

ⓘ The engine speed will automatically decrease to about 2000 r/min. If equipped with a low oil pressure-alert indicator, it will light or blink.

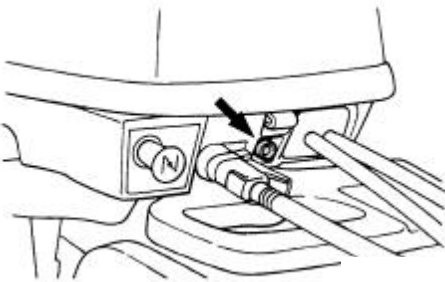

ⓘ The buzzer will sound (if equipped on the tiller handle, remote control box, or main switch panel).

If the alert system has activated, stop the engine as soon as it is safe to do so. Check the oil level and add oil as needed. If the oil level is correct and the alert device does not switch off, consult your Outboards dealer.

## Installation

The information presented in this section is intended as reference only. It is not possible to provide complete instructions for every possible boat and motor combination. Proper mounting depends in part on experience and the specific boat and motor combination.

- ⚠ **Overpowering a boat could cause severe instability. Do not install an outboard motor with more horsepower than the maximum rating on the capacity plate of the boat. If the boat does not have a capacity plate, consult the boat manufacturer.**
- ⚠ **Improper mounting of the outboard motor could result in hazardous conditions such as poor handling, loss of control, or fire hazards. For permanently mounted models, your dealer or other person experienced in proper rigging should mount the motor.**

### Mounting the outboard motor

#### **NOTICE**

**Do not hold the top cowling when mounting or dismounting the outboard motor. The top cowling could come off, causing the outboard motor to fall.**

1. Be sure to mount the outboard motor while the boat is on land. If the boat is on the water, move it to an area on land.
2. To prevent steering movement, turn the adjuster lever to "A" (if equipped with the adjuster lever). To hold the steering bracket easily, raise the tiller handle to the vertical position (if equipped with the tiller handle).

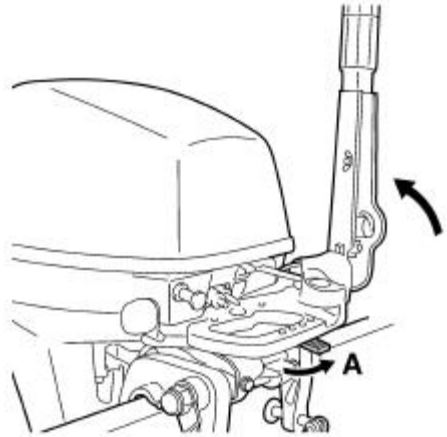

3. Hold the handgrip and steering bracket as shown in the illustration and lift up the outboard motor using two people.

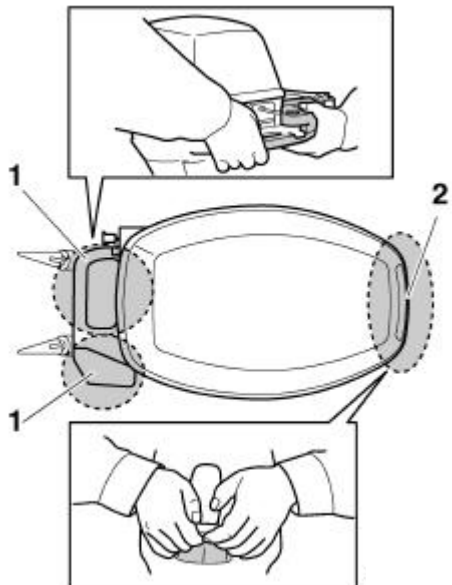

1. Steering bracket
2. Handgrip

# Installation

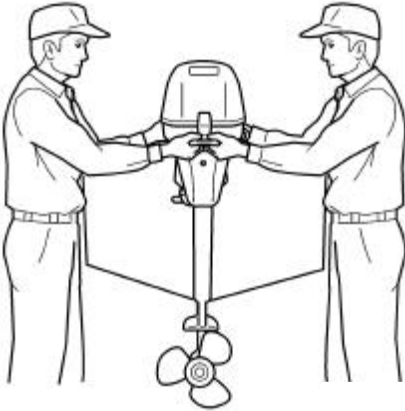

4. Mount the outboard motor on the center line (keel line) of the boat, and ensure that the boat itself is well balanced. Otherwise the boat will be hard to steer. For boats without a keel or which are asymmetrical, consult your dealer.

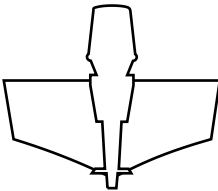

1

1. Center line (keel line)

## Mounting height

To run your boat at optimum efficiency, the water resistance (drag) of the boat and outboard motor must be made as little as possible. The mounting height of the outboard motor greatly affects the water resistance. If the mounting height is too high, cavitation tends to occur, thus reducing the propulsion; and if the propeller tips cut the air, the engine

speed will rise abnormally and cause the engine to overheat. If the mounting height is too low, the water resistance will increase and thereby reduce engine efficiency. Mount the outboard motor so that the anti-cavitation plate is between the bottom of the boat and a level 25 mm (1 in) below it.

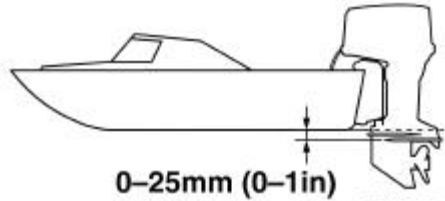

## NOTICE

- ⚠ **Make sure that the idle hole is high enough to prevent water from entering the engine even if the boat is stationary with the maximum load.**
- ⚠ **Incorrect engine height or obstructions to the smooth flow of water (such as the design or condition of the boat, or accessories, such as transom ladders or depth finder transducers) can create airborne water spray while the boat is cruising. If the outboard motor is operated continuously in the presence of airborne water spray, enough water could enter the engine through the air intake opening in the top cowling to cause severe engine damage. Remove the cause of the airborne water spray.**

## TIP:

- ⚠ The optimum mounting height of the outboard motor is affected by the boat and motor combination and the desired use. Test

runs at different heights can help determine the optimum mounting height. Consult your Outboards dealer or boat manufacturer for further information on determining the proper mounting height.

¶ For instructions on setting the trim angle of the outboard motor, see page 47.

## Clamping the outboard motor

1. Place the outboard motor on the transom so that it is positioned as close to the center as possible. Tighten the transom clamp screws evenly and securely. Occasionally check the clamp screws for tightness during operation of the outboard motor because they could become loose due to engine vibration.

**WARNING! Loose clamp screws could allow the outboard motor to fall off or move on the transom. This could cause loss of control and serious injury. Make sure the clamp screws are tightened securely. Occasionally check the screws for tightness during operation.**

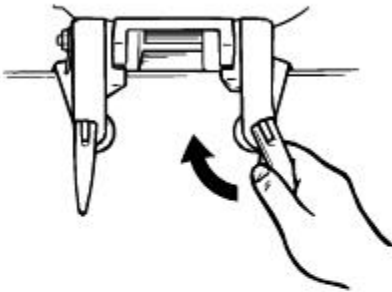

2. If the restraint cable attachment is equipped on your engine, a restraint cable or chain should be used. Attach one end to the restraint cable attachment and the other to a secure mounting point on

the boat. Otherwise the engine could be completely lost if it accidentally falls off the transom.

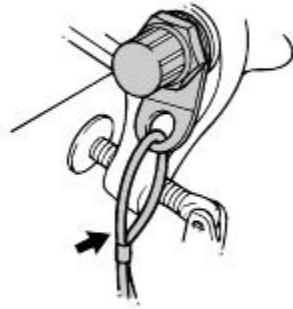

3. Secure the clamp bracket to the transom using the bolts provided with the outboard (if packed). For details, consult your Outboards dealer. **WARNING! Avoid using bolts, nuts or washers other than those contained in the engine packaging. If used, they must be of at least the same quality of material and strength and must be tightened securely. After tightening, test run the engine and check their tightness.**

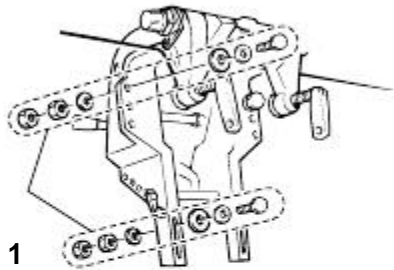

1. Bolts

# Operation

## First-time operation

### Fill engine oil

The engine is shipped from the factory without engine oil. If your dealer did not fill the oil, you must fill it before starting the engine. **NOTICE:**

**Check that the engine is filled with oil before first-time operation to avoid severe engine damage.**

The engine is shipped with the following sticker, which should be removed after engine oil is filled for the first time. For more information on checking the engine oil level, see page 34.



### Breaking in engine

Your new engine requires a period of break-in to allow mating surfaces of moving parts to wear in evenly. Correct break-in will help ensure proper performance and longer engine life. **NOTICE: Failure to follow the break-in procedure could result in reduced engine life or even severe engine damage.**

#### Procedure for 4-stroke models

Your new engine requires a period of 10 hours break-in to allow mating surfaces of moving parts to wear in evenly.

#### TIP:

Run the engine in the water, under load (in gear with a propeller installed) as follows. For 10 hours for breaking in engine avoid extended idling, rough water and crowded areas.

1. For the first hour of operation:  
Run the engine at varying speeds up to 2000 r/min or approximately half throttle.
2. For the second hour of operation:  
Increase engine speed as much as necessary to put the boat on plane (but avoid full-throttle operation), then back off on the throttle while keeping the boat at a planing speed.
3. Remaining 8 hours:  
Run the engine at any speed. However, avoid operating at full throttle for more than 5 minutes at a time.
4. After the first 10 hours:  
Operate the engine normally.

### Getting to know your boat

Different boats handle differently. Operate cautiously while you learn how your boat handles under different conditions and with different trim angles (see page 47).

## Checks before starting engine

**If any item in “Checks before starting engine” is not working properly, have it inspected and repaired before operating the outboard motor. Otherwise, an accident could occur.**

#### NOTICE

**Do not start the engine out of water. Overheating and serious engine damage can occur.**

#### Fuel level

Be sure you have plenty of fuel for your trip. A good rule is to use 1/3 of your fuel to get to the destination, 1/3 to return, and to keep 1/3 as

an emergency reserve. With the boat level on a trailer or in the water, check the fuel level. For fuel filling instructions, see page 36.

## Remove the top cowling

For the following checks, remove the top cowling from the bottom cowling. To remove the top cowling, release the cowling lock lever and lift off the top cowling.

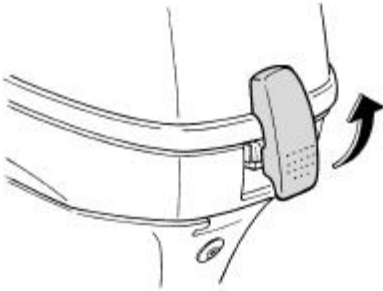

## Fuel system

**Gasoline and its vapors are highly flammable and explosive. Keep away from sparks, cigarettes, flames, or other sources of ignition.**

**Leaking fuel can result in fire or explosion.**

- ☞ Check for fuel leakage regularly.
- ☞ If any fuel leakage is found, the fuel system must be repaired by a qualified mechanic. Improper repairs can make the outboard unsafe to operate.

### Check for fuel leaks

- ☞ Check for fuel leaks or gasoline fumes in the boat.
- ☞ Check for fuel leakage from the fuel system.
- ☞ Check the fuel tank and fuel lines for cracks, swellings, or other damages.

## Controls

Tiller handle models:

- ☞ Move the tiller handle fully to the left and right to make sure operation is smooth.
- ☞ Turn the throttle grip from the fully closed to the fully open position. Make sure that it turns smoothly and that it completely returns to the fully closed position.
- ☞ Look for loose or damaged connections of the throttle and shift cables.

Remote control models:

- ☞ Turn the steering wheel full-right and full-left. Make sure operation is smooth and unrestricted throughout the whole range with no binding or excessive free play.
- ☞ Operate the throttle levers several times to make sure there is no hesitation in their travel. Operation should be smooth over the complete range of motion, and each lever should return completely to the idle position.
- ☞ Look for loose or damaged connections of the throttle and shift cables.

## Engine shut-off cord (lanyard)

Inspect the engine shut-off cord and clip for damage, such as cuts, breaks, and wear.

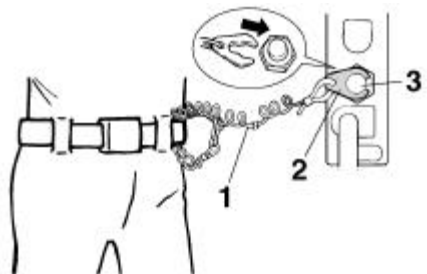

1. Cord
2. Clip
3. Engine shut-off switch

# Operation

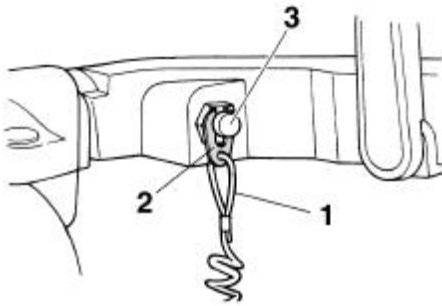

1. Cord
2. Clip
3. Engine shut-off switch

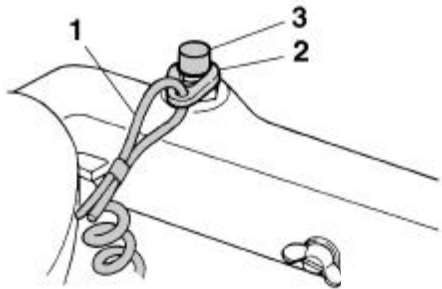

1. Cord
2. Clip
3. Engine shut-off switch

## Engine oil

1. Put the outboard motor in an upright position (not tilted). **NOTICE: If the motor is not level, the oil level indicated on the dipstick may not be accurate.**
2. Remove oil dipstick and wipe it clean.
3. Insert the dipstick and remove it again. Be sure to completely insert the dipstick into the dipstick guide, otherwise the oil level measurement will be incorrect.

4. Check the oil level using the dipstick to be sure the level falls between the upper and lower marks. Fill with oil if it is below the lower mark, or drain to the specified level if it is above the upper mark.

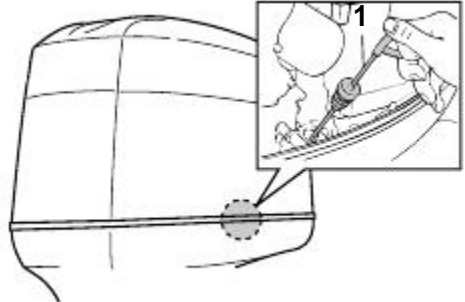

1. Oil dipstick

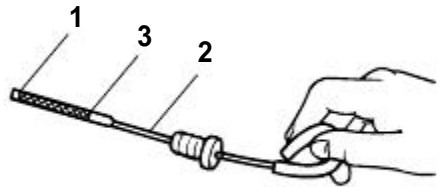

1. Lower level mark
2. Oil dipstick
3. Upper level mark

## Engine

- ⌘ Check the engine and engine mounting.
- ⌘ Look for loose or damaged fasteners.
- ⌘ Check the propeller for damage.
- ⌘ Check for engine oil leaks.

## Flushing device

Check that the flushing device's garden hose connector is securely screwed on to the fitting on the bottom cowling. **NOTICE: If the garden hose connector is not properly con-**



nected, cooling water can leak out and the engine can overheat during operation.

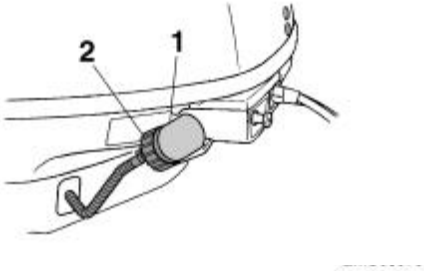

1. Fitting
2. Flushing device

## Install top cowling

1. Be sure that the cowling lock lever is released.
2. Be sure that the rubber seal is seated all the way around the top cowling.
3. Place the top cowling on the bottom cowling.
4. Check to be sure the rubber seal is seated correctly between the top cowling and the bottom cowling.
5. Move the lever to lock the cowling as shown. **NOTICE: If the top cowling is not installed correctly, water spray under the top cowling can damage the engine, or the top cowling can blow off at high speeds.**

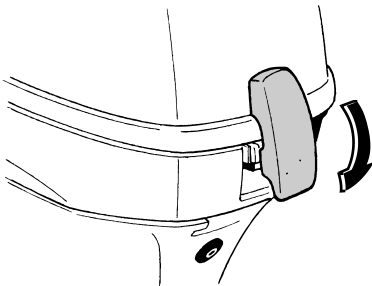

After installing, check the fitting of the top cowling by pushing it with both hands. If the top cowling is loose, have it repaired by your Outboards dealer.



## Checking power tilt system

- ⚠ **Never get under the lower unit while it is tilted, even when the tilt support knob is locked. Severe injury could occur if the outboard motor accidentally falls.**
- ⚠ **Body parts can be crushed between the motor and the clamp bracket when the motor is trimmed or tilted.**
- ⚠ **Be sure no one is near the outboard motor before performing this check.**

1. Check the power tilt unit for any sign of oil leaks.

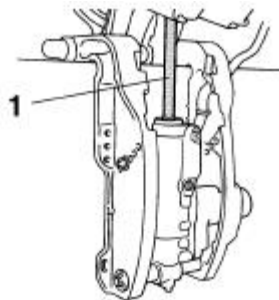

1. Tilt rod

# Operation

2. Operate each of the power tilt switches to check that all switches work.
3. Tilt the outboard motor up and check that the tilt rod is pushed out completely.
4. Check that the tilt rod is free of corrosion or other flaws.
5. Tilt the outboard motor down. Check that the tilt rod operates smoothly.

## Battery

Check that the battery is in good condition, and fully charged. Check that the battery connections are clean, secure and covered by insulating covers. The electrical contacts of the battery and cables must be clean and properly connected or the battery will not start the engine.

Refer to the battery manufacturer's instructions for checks for your particular battery.

## Filling fuel

- ⚠ **Gasoline and its vapors are highly flammable and explosive. Always refuel according to this procedure to reduce the risk of fire and explosion.**
  - ⚠ **Gasoline is poisonous and can cause injury or death. Handle gasoline with care. Never siphon gasoline by mouth. If you should swallow some gasoline or inhale a lot of gasoline vapor, or get some gasoline in your eyes, see your doctor immediately. If gasoline spills on your skin, wash with soap and water. If gasoline spills on your clothing, change your clothes.**
1. Be sure the engine is stopped.
  2. Disconnect the fuel line from the fuel tank and tighten the air vent screw on the fuel tank cap.

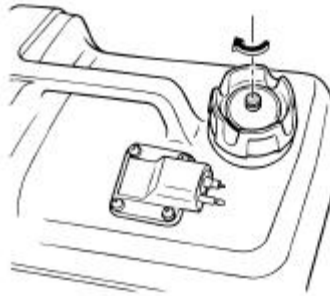
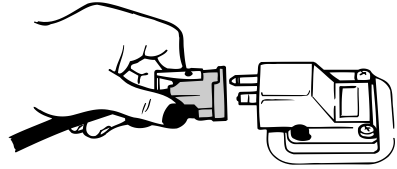

3. Remove the portable tank from the boat.
4. Be sure you are in a well-ventilated outdoor area, either securely moored or trailered.
5. Do not smoke and keep away from sparks, flames, static electric discharge, or other sources of ignition.
6. If you use a portable container to store and dispense fuel, use only an approved GASOLINE container.
7. Touch the fuel nozzle to the filler opening or funnel to help prevent electrostatic sparks.
8. Fill the fuel tank, but do not overfill. **WARNING! Do not overfill. Otherwise fuel can expand and overflow if the temperature increases.**

Fuel tank capacity:

12.0 L (3.17 US gal, 2.64 Imp.gal)



9. Tighten the filler cap securely.
10. Wipe up any spilled gasoline immediately with dry rags. Dispose rags properly according to local laws or regulations.

## Operating engine

- ⓘ **Before starting the engine, make sure that the boat is tightly moored and that you can steer clear of any obstructions. Be sure there are no swimmers in the water near you.**
- ⓘ **When the air vent screw is loosened, gasoline vapor will be released. Gasoline is highly flammable, and its vapors are flammable and explosive. Refrain from smoking, and keep away from open flames and sparks while loosening the air vent screw.**
- ⓘ **This product emits exhaust gases which contain carbon monoxide, a colorless, odorless gas which could cause brain damage or death when inhaled. Symptoms include nausea, dizziness, and drowsiness. Keep cockpit and cabin areas well ventilated. Avoid blocking exhaust outlets.**

## Sending fuel (portable tank)

1. If there is an air vent screw on the fuel tank cap, loosen it 2 or 3 turns.

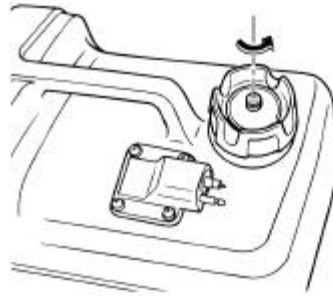

2. If there is a fuel joint on the motor, align the fuel joint on the fuel line with the fuel joint on the motor and firmly connect the fuel line to the joint while pinching the joint. Then firmly connect the other end of the fuel line to the joint on the fuel tank.

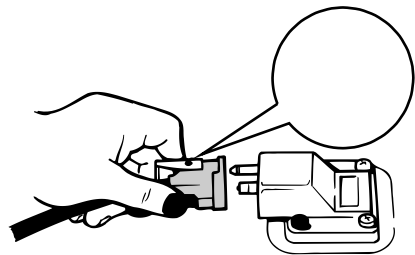
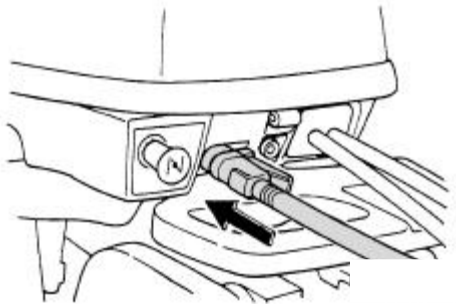

# Operation

## TIP:

Wipe up any spilled gasoline immediately with dry rags. Dispose rags properly according to local laws or regulations.

3. Squeeze the primer pump, with the arrow pointing up, until you feel it become firm. During engine operation place the tank horizontally, otherwise fuel cannot be drawn from the fuel tank.

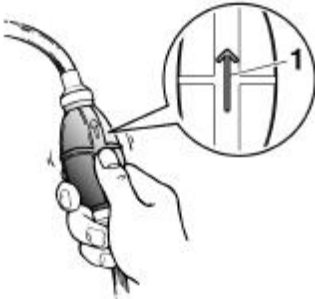

1. Arrow

## Starting engine

Before starting the engine, make sure that the boat is tightly moored and that you can steer clear of any obstructions. Be sure there are no swimmers in the water near you.

### Manual start models (tiller control)

- ⚠ **Failure to attached engine shut-off cord could result in a runaway boat if operator is ejected. Attach the engine shut-off cord to a secure place on your clothing, or your arm or leg while operating. Do not attach the cord to clothing that could tear loose. Do not route the cord where it could become entangled, preventing it from functioning.**

- ⚠ **Avoid accidentally pulling the cord during normal operation. Loss of engine power means the loss of most steering control. Also, without engine power, the boat could slow rapidly. This could cause people and objects in the boat to be thrown forward.**

### Starting procedure (cold engine)

1. Place the gear shift lever in neutral.

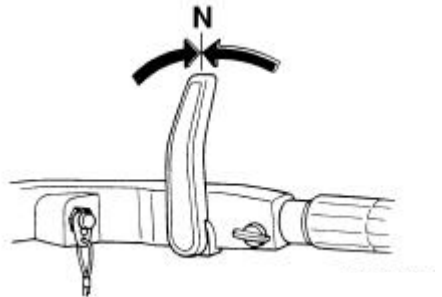
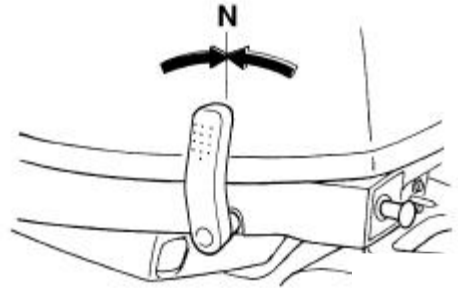

## TIP:

The start-in-gear protection device prevents the engine from starting except when in neutral.

2. Attach the engine shut-off cord to a secure place on your clothing, or your arm or leg. Then install the clip on the other end of the cord into the engine shut-off switch.

# Operation

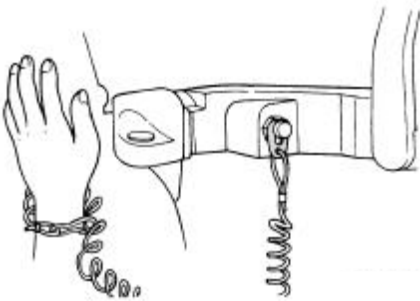
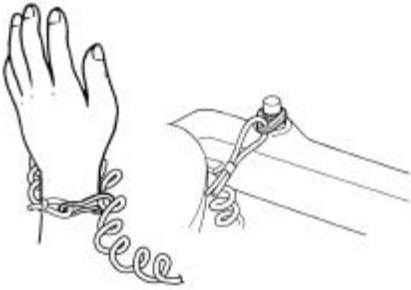

3. Place the throttle grip in the “ sTAR ” (start) position.

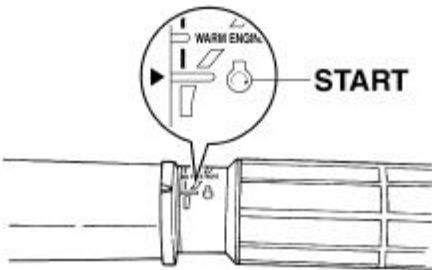

4. Pull out the choke knob fully.

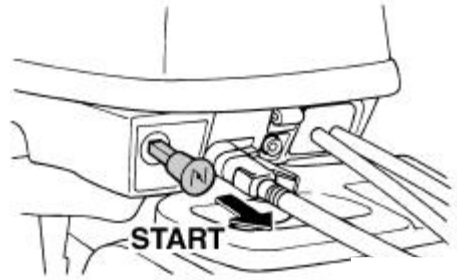

5. Pull the manual starter handle slowly until you feel resistance. Then give a strong pull straight out to crank and start the engine.

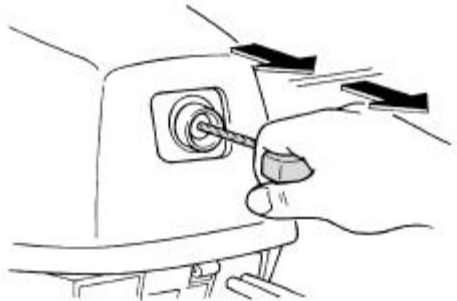

6. After the engine starts, slowly return the manual starter handle to its original position before releasing it.  
7. Slowly return the throttle grip to the fully closed position.

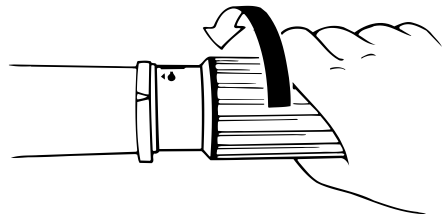

8. Return the choke knob to the home position gradually.

# Operation

## TIP:

- ⦿ If the choke knob is left in the “S TART” (start) position while the engine is running, the engine will run poorly or stall.
- ⦿ When the engine is cold, for example, when the ambient temperature is low in winter, it needs to be warmed up. For further information, see page 43.
- ⦿ Do not turn the throttle grip unnecessarily to open and close the throttle before starting the engine, otherwise the engine may be difficult to start. If the engine is difficult to start, place the throttle grip in the “WARM G” (warm engine) position and try again.

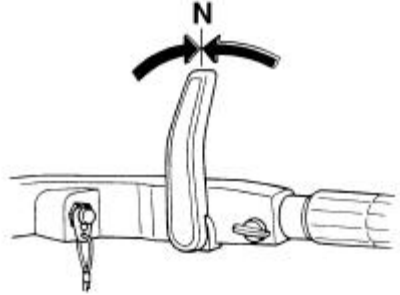

2. Attach the engine shut-off cord to a secure place on your clothing, or your arm or leg. Then install the clip on the other end of the cord into the engine shut-off switch.

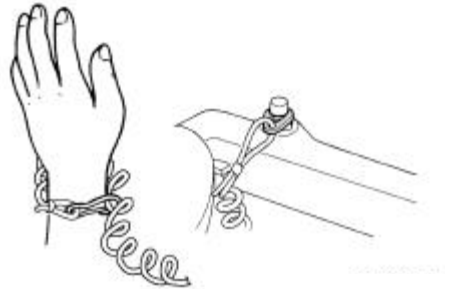
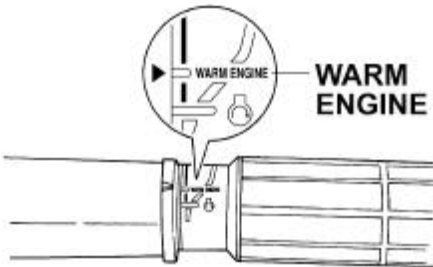

## Starting procedure (warm engine)

1. Place the gear shift lever in neutral.

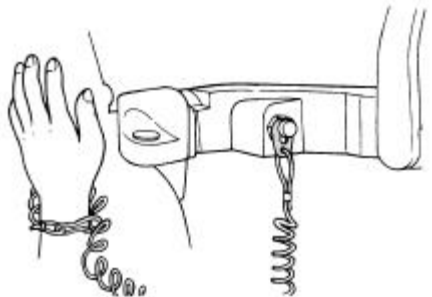
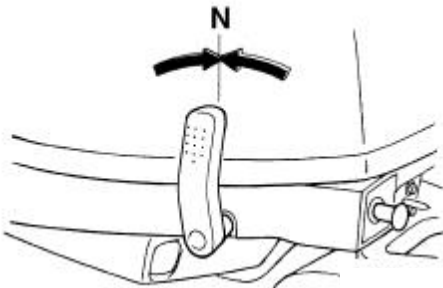

3. Place the throttle grip in the “S TART” (start) position.

# Operation

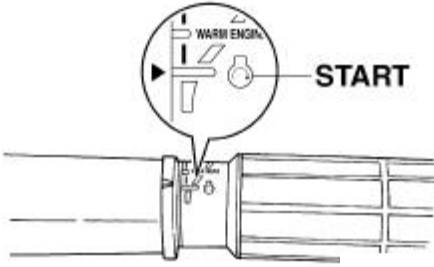

4. Pull the manual starter handle slowly until you feel resistance. Then give a strong pull straight out to crank and start the engine.

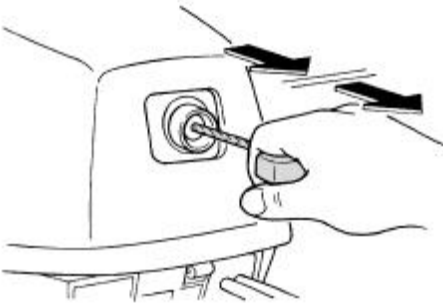

## TIP:

- ⦿ If the engine does not start, place the throttle grip in the "WARM G" (warm engine) position and try again.

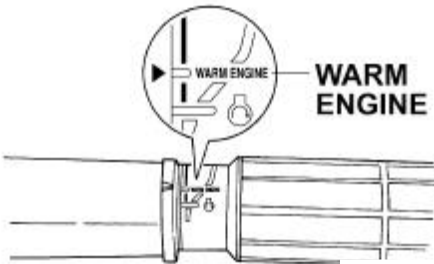

- ⦿ It is not necessary to use the choke when starting a warm engine.

5. After the engine starts, slowly return the manual starter handle to its original position before releasing it.
6. Slowly return the throttle grip to the fully closed position.

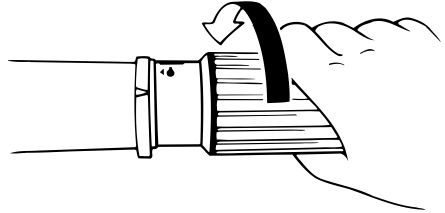

## Electric start models (remote control)

- ⦿ Failure to attach engine shut-off cord could result in a runaway boat if operator is ejected. Attach the engine shut-off cord to a secure place on your clothing, or your arm or leg while operating. Do not attach the cord to clothing that could tear loose. Do not route the cord where it could become entangled, preventing it from functioning.
- ⦿ Avoid accidentally pulling the cord during normal operation. Loss of engine power means the loss of most steering control. Also, without engine power, the boat could slow rapidly. This could cause people and objects in the boat to be thrown forward.

1. Place the remote control lever in neutral.

# Operation

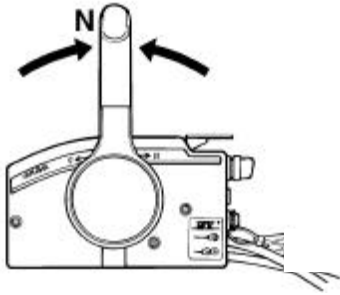

## TIP:

The start-in-gear protection device prevents the engine from starting except when in neutral.

2. Attach the engine shut-off cord to a secure place on your clothing, or your arm or leg. Then install the clip on the other end of the cord into the engine shut-off switch.

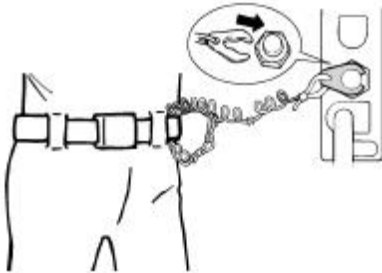

3. Turn the main switch to "ON" (on).

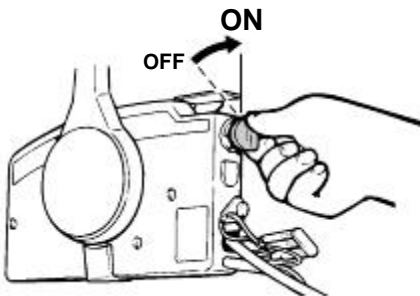

4. Open the throttle slightly without shifting using the neutral throttle lever.

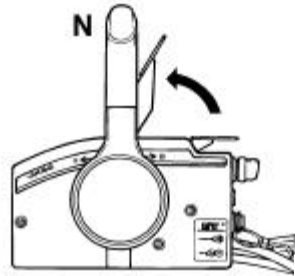

## TIP:

The neutral throttle lever can only be used when the remote control lever is in neutral.

5. Press in and hold the main switch to operate the remote choke system. (The remote choke system operates only when the main switch is pressed in fully.)



## TIP:

It is not necessary to use the choke when starting a warm engine.

6. Turn the main switch to "START" (start) to start the engine.



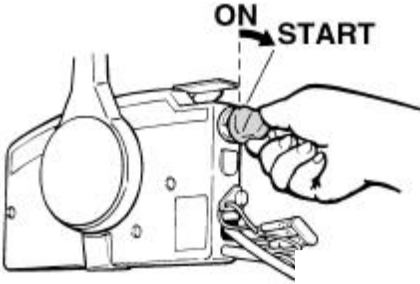

7. Immediately after the engine starts, release the main switch and allow it to return to “**o**” (on). The remote choke system stops operating when the main switch is released. **NOTICE: Never turn the main switch to “ S<sup>T</sup>AR ” (start) while the engine is running. Do not keep the starter motor turning for more than 5 seconds. If the starter motor is turned continuously for more than 5 seconds, the battery will be quickly discharged, thus making it impossible to start the engine. The starter can also be damaged. If the engine will not start after 5 seconds of cranking, return the main switch to “**o**” (on), wait 10 seconds, then crank the engine again.**
8. Return the neutral throttle lever to the original position.

## TIP:

When the engine is cold, for example, when the ambient temperature is low in winter, it needs to be warmed up. For further information, see page 43.

## Checks after starting engine

### Cooling water

Check for a steady flow of water from the cooling water pilot hole. A continuous flow of water from the pilot hole indicates that the water

pump is pumping water through the cooling water passages. If the cooling water passages are frozen, it may take a while for water to start flowing out of the pilot hole.

## NOTICE

If water is not flowing out of the pilot hole at all times while the engine is running, overheating and serious damage could occur. Stop the engine and check whether the cooling water inlet on the lower case or the cooling water pilot hole is blocked. Consult your Outboards dealer if the problem cannot be located and corrected.



## Warming up engine

### Manual start and electric start models

1. After starting the engine, allow it to idle for 3 minutes to warm up. Failure to do so will shorten engine life.
2. Be sure the low oil pressure-alert indicator goes off after starting the engine. **NOTICE: If the low oil pressure-alert indicator blinks after the engine starts, stop the engine. Otherwise, serious engine damage could occur. Check the oil level and add engine oil if necessary. Consult your Outboards dealer if the cause for the low oil pressure alert cannot be found.** [ECM01831]

# Operation

## Checks after engine warm up

### Shifting

While the boat is tightly moored, and without applying throttle, confirm that the engine shifts smoothly into forward and reverse, and back to neutral.

### Stop switches

- Turn the main switch to “**O**”, or press the engine stop button and make sure the engine stops.
- Confirm that removing the clip from the engine shut-off switch stops the engine.
- Confirm that the engine cannot be started with the clip removed from the engine shut-off switch.

## Shifting

**Before shifting, make sure there are no swimmers or obstacles in the water near you.**

### NOTICE

Warm up the engine before shifting into gear. Until the engine is warm, the idle speed may be higher than normal. High idle speed can prevent you from shifting back to neutral. If this occurs, stop the engine, shift to neutral, then restart the engine and allow it to warm up.

### To shift out of neutral

1. Pull the neutral interlock trigger up (if equipped).

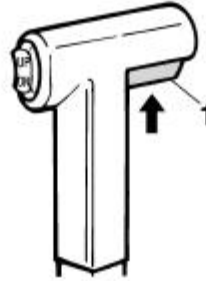

1. Neutral interlock trigger
2. Move the remote control lever / gear shift lever firmly and crisply forward (for forward gear) or backward (for reverse gear) [about 35° (a detent can be felt) for remote control models]. Be sure to check that the tilt lock lever is in the lock/down position (if equipped) before operating in reverse.

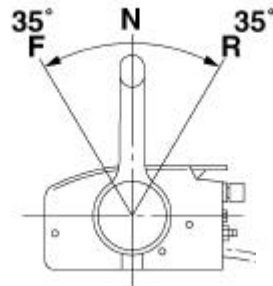
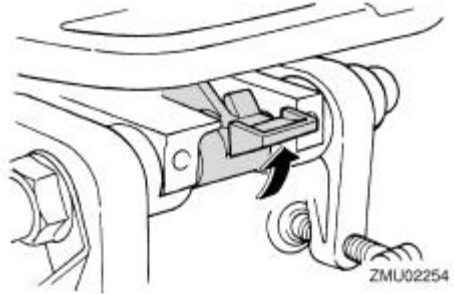

# Operation

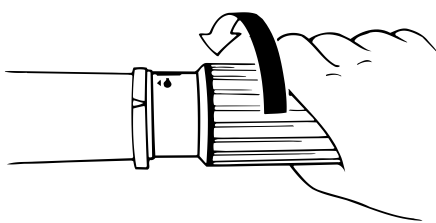
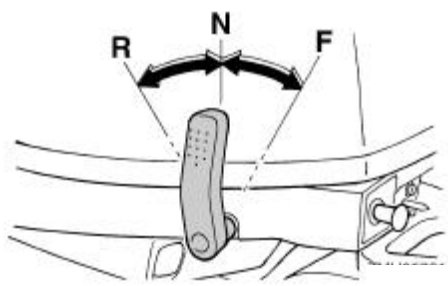

2. After the engine is at idle speed in gear move the remote control lever / gear shift lever firmly and crisply into the neutral position.

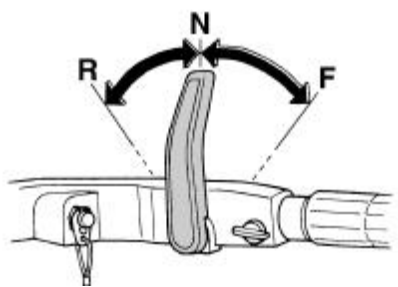

To shift from in gear (forward/reverse) to neutral

1. Close the throttle so that the engine slows to idle speed.

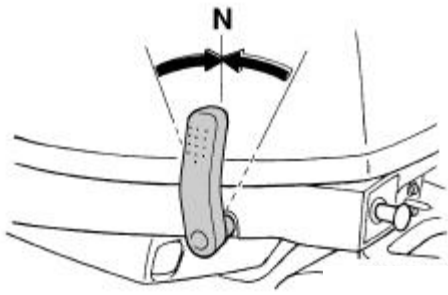
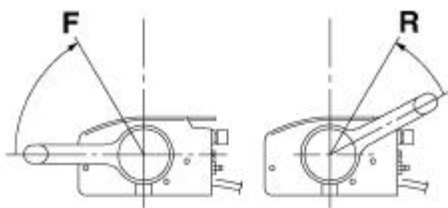
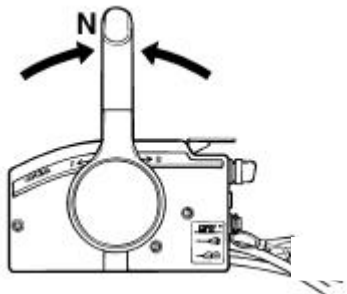

# Operation

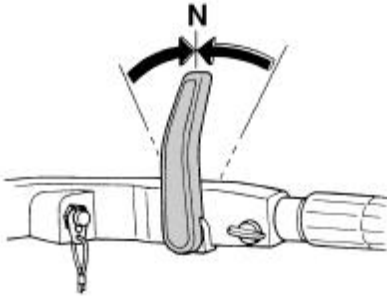

## Stopping boat

- ⚠ Do not use the reverse function to slow down or stop the boat as it could cause you to lose control, be ejected, or impact the steering wheel or other parts of the boat. This could increase the risk of serious injury. It could also damage the shift mechanism.
- ⚠ Do not shift into reverse while traveling at planing speeds. Loss of control, boat swamping, or damage to the boat could occur.

The boat is not equipped with a separate braking system. Water resistance stops it after the throttle lever is moved back to idle. The stopping distance varies depending on gross weight, water surface conditions, and wind direction.

## Stopping engine

Before stopping the engine, first let it cool off for a few minutes at idle or low speed. Stopping the engine immediately after operating at high speed is not recommended.

### Procedure

1. Push and hold the engine stop button until the engine comes to a complete stop.

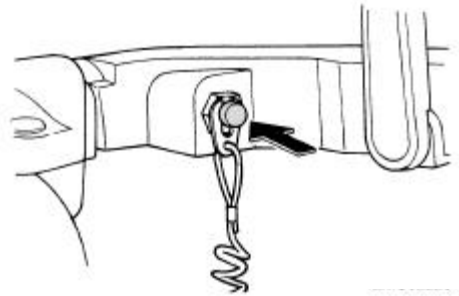
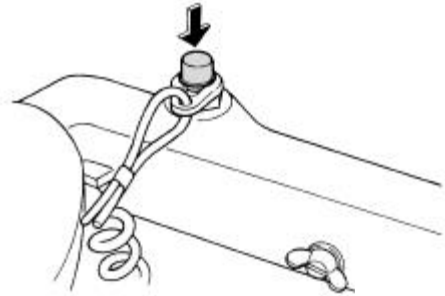

2. After stopping the engine, tighten the air vent screw on the fuel tank cap and set the fuel cock lever or knob to the closed position, if equipped.

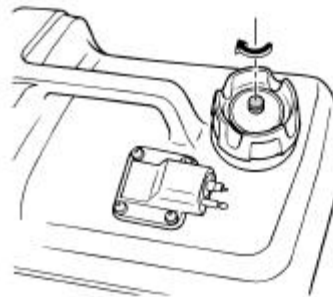

3. Disconnect the fuel line if you are using an external fuel tank.

## Trimming outboard motor

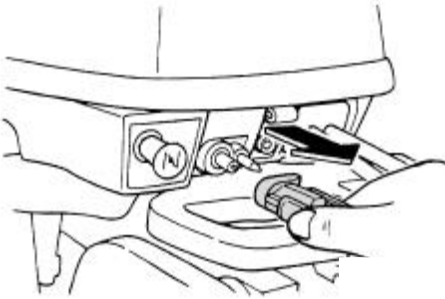

### TIP:

If the outboard motor is equipped with an engine shut-off cord, the engine can also be stopped by pulling the cord and removing the clip from the engine shut-off switch.

### Procedure

1. Turn the main switch to "O" (off).

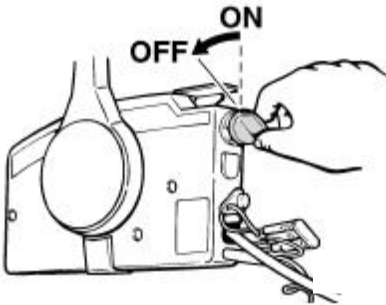

2. After stopping the engine, disconnect the fuel line or close the fuel cock if there is a fuel joint or a fuel cock on the boat.
3. Tighten the air vent screw on the fuel tank cap (if equipped).
4. Remove the key if the boat will be left unattended.

### TIP:

The engine can also be stopped by pulling the cord and removing the clip from the engine shut-off switch, then turning the main switch to "O" (off).

Excessive trim for the operating conditions (either trim up or trim down) can cause boat instability and can make steering the boat more difficult. This increases the possibility of an accident. If the boat begins to feel unstable or is hard to steer, slow down and/or readjust the trim angle.

The trim angle of the outboard motor helps determine the position of the bow of the boat in the water. Correct trim angle will help improve performance and fuel economy while reducing strain on the engine. Correct trim angle depends upon the combination of boat, engine, and propeller. Correct trim is also affected by variables such as the load in the boat, sea conditions, and running speed.



1. Trim operating angle

### Adjusting trim angle for manual tilt models

There are 4 or 5 holes provided in the clamp bracket to adjust the outboard motor trim angle.

1. Stop the engine.
2. Tilt the outboard motor up, and then remove the trim rod from the clamp bracket.

# Operation

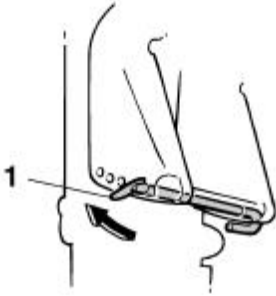

1. Trim rod

3. Reposition the rod in the desired hole. To raise the bow (“trim-out”), move the rod away from the transom.

To lower the bow (“trim-in”), move the rod toward the transom.

Make test runs with the trim set to different angles to find the position that works best for your boat and operating conditions.

- ⚠ **Stop the engine before adjusting the trim angle.**
- ⚠ **Use care to avoid being pinched when removing or installing the rod.**
- ⚠ **Use caution when trying a trim position for the first time. Increase speed gradually and watch for any signs of instability or control problems. Improper trim angle can cause loss of control.**

## TIP:

The outboard motor trim angle can be changed approximately 4 degrees by shifting the trim rod one hole.

## Adjusting trim angle (power tilt models)

- ⚠ **Be sure all people are clear of the outboard motor when adjusting the trim angle. Body parts can be crushed between the motor and the clamp bracket when the motor is trimmed or tilted.**
- ⚠ **Use caution when trying a trim position for the first time. Increase speed gradually and watch for any signs of instability or control problems. Improper trim angle can cause loss of control.**
- ⚠ **If equipped with a power trim and tilt switch located on the bottom cowling, use the switch only when the boat is at a complete stop with the engine off. Do not adjust the trim angle with this switch while the boat is moving.**

Tilt the engine to the desired angle using the power tilt switch.

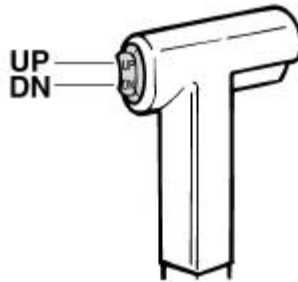

## TIP:

Stay within the trim operating angle when trimming the outboard motor using the power tilt system.

To raise the bow (“trim-out”), tilt the engine up.

To lower the bow (“trim-in”), tilt the engine down.

Make test runs with the trim set to different angles to find the position that works best for your boat and operating conditions.

## Adjusting boat trim

When the boat is on plane, a bow-up attitude results in less drag, greater stability and efficiency. This is generally when the keel line of the boat is up about 3 to 5 degrees. With the bow up, the boat may have a greater tendency to steer to one side or the other. Compensate for this as you steer. When the bow of the boat is down, it is easier to accelerate from a standing start onto plane.

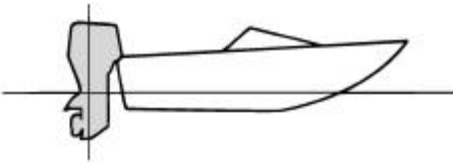

### Bow Up

Too much trim-out puts the bow of the boat too high in the water. Performance and economy are decreased because the hull of the boat is pushing the water and there is more air drag. Excessive trim-out can also cause the propeller to ventilate, which reduces performance further, and the boat may “porpoise” (hop in the water), which could throw the operator and passengers overboard.

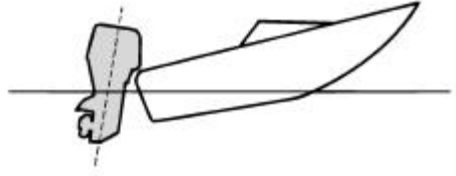

### Bow Down

Too much trim-in causes the boat to “plow” through the water, decreasing fuel economy and making it hard to increase speed. Operating with excessive trim-in at higher speeds also makes the boat unstable. Resistance at the bow is greatly increased, heightening the danger of “bow steering” and making operation difficult and dangerous.



### TIP:

Depending on the type of boat, the outboard motor trim angle may have little effect on the trim of the boat when operating.

## Tilting up and down

If the engine will be stopped for some time or if the boat is moored in shallows, the outboard motor should be tilted up to protect the propeller and lower casing from damage by collision with obstructions, and also to reduce salt corrosion.

# Operation

Make sure that no one is near the outboard motor when tilting the outboard motor up or down. Otherwise, body parts could be crushed between the outboard motor and the clamp bracket.

Leaking fuel is a fire hazard. If there is a fuel joint on the outboard motor, disconnect the fuel line or close the fuel cock if the engine will be tilted for more than a few minutes. Otherwise fuel may leak.

## NOTICE

- ⚠ Before tilting the outboard motor, stop the engine by following the procedure on page 46. Never tilt the outboard motor while the engine is running. Severe damage from overheating can result.
- ⚠ Do not tilt up the engine by pushing the tiller handle (if equipped) because this could break the handle.

## Procedure for tilting up (manual tilt models)

1. Place the remote control lever / gear shift lever in neutral.

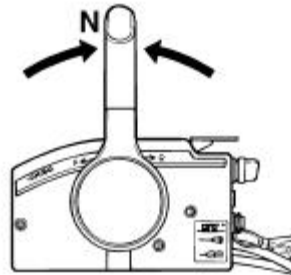
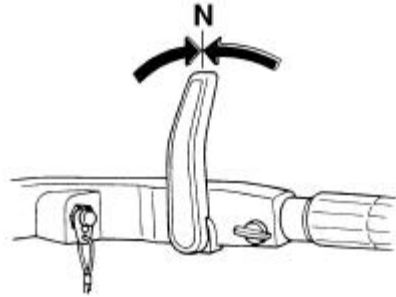
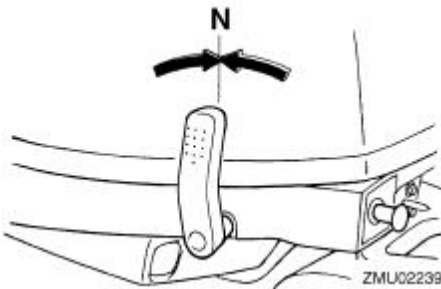

2. Disconnect the fuel line from the outboard motor.

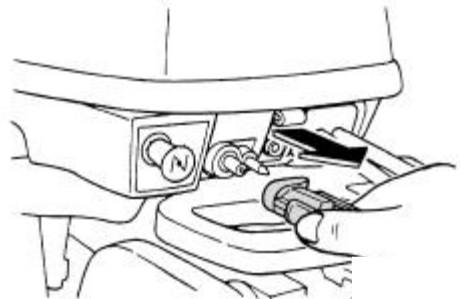

3. Place the tilt lock lever (if equipped) in the release/up position.



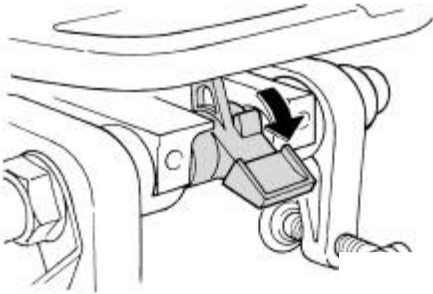

4. Pull up the shallow water lever (if equipped).
5. Hold the rear of the top cowling with one hand and tilt the engine up fully.
6. Push the tilt support knob into the clamp bracket. Or the tilt support bar will turn to the lock position automatically. **NOTICE:** Do not use the tilt support lever or knob when trailering the boat. The outboard motor could shake loose from the tilt support and fall. If the motor cannot be trailered in the normal running position, use an additional support device to secure it in the tilt position. For more detailed information, see page 56. [ECM01641]

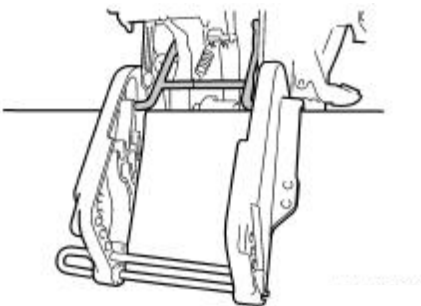

## Procedure for tilting up (power tilt models)

1. Place the remote control lever in neutral.

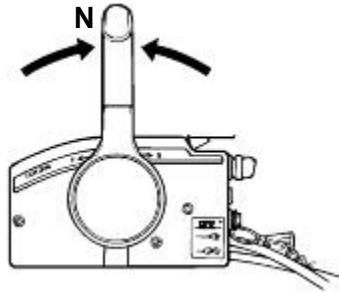

2. Press the power tilt switch “UP (up)” until the outboard motor has tilted up completely.

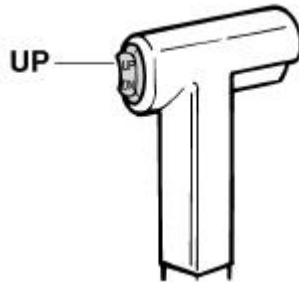

3. Push the tilt support knob into the clamp bracket to support the engine. **WARNING!** After tilting the outboard motor, be sure to support it with the tilt support knob or tilt support lever. Otherwise the outboard motor could fall back down suddenly if oil in the power trim and tilt unit or in the power tilt unit loses pressure. [EWM00262] **NOTICE:** Do not use the tilt support lever or knob when trailering the boat. The outboard motor could shake loose from the tilt support and fall. If the motor cannot be trailered in the normal running position, use an additional support device to secure it in the tilt position. For more detailed information, see page 56.

# Operation

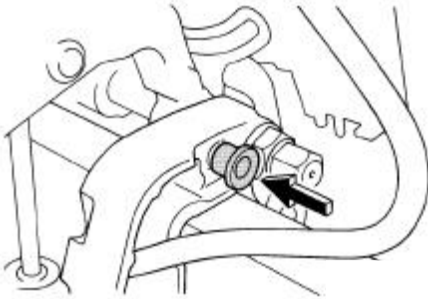

4. Models equipped with trim rods: Once the outboard motor is supported with the tilt support lever, press the power tilt switch “**⬇**” (down) to retract the trim rods.  
**NOTICE: Make sure that the trim rods retract completely during mooring. This protects the rods from marine growth and corrosion, which could damage the power trim and tilt mechanism.**

## Procedure for tilting down (manual tilt models)

1. Place the tilt lock lever in the lock position.

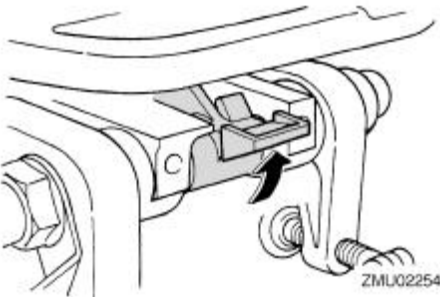

2. Slightly tilt the engine up until the tilt support bar is automatically released.
3. Slowly tilt the engine down.

## Procedure for tilting down (power tilt models)

1. Push the power tilt switch “**⬆**” (up) until the outboard motor is supported by the tilt rod and the tilt support knob becomes free.
2. Pull out the tilt support knob.

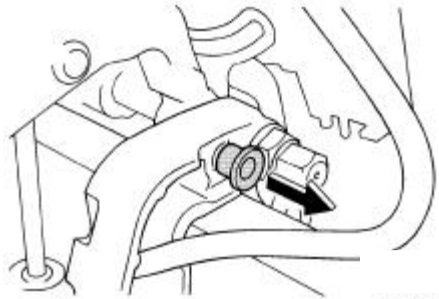

3. Push the power tilt switch “**⬇**” (down) to lower the outboard motor to the desired position.

DN

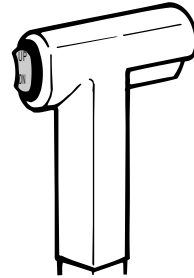

**Shallow water**

## Cruising in shallow water (manual tilt models)

- ⦿ **Run the boat at the lowest possible speed when using the shallow water cruising system. The tilt lock mechanism does not work while the shallow**

# Operation

water cruising system is being used. Hitting an underwater obstacle could cause the outboard motor to lift out of the water, resulting in loss of control.

- Use extra care when operating in reverse. Too much reverse thrust can cause the outboard motor to lift out of the water, increasing the chance of accident and personal injury.

## NOTICE

Do not tilt the outboard motor up so that the cooling water inlet on the lower unit is above the surface of the water when setting up for and cruising in shallow water. Otherwise severe damage from overheating can result.



## Procedure

1. Place the remote control lever / gear shift lever in neutral.

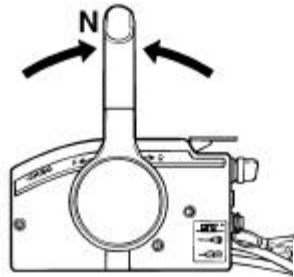
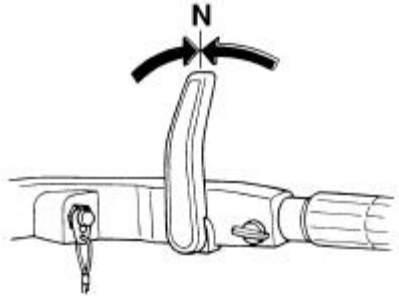
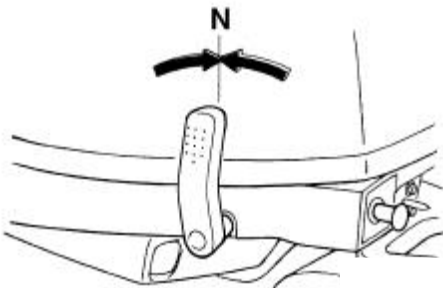

2. Place the tilt lock lever in the release/up position.

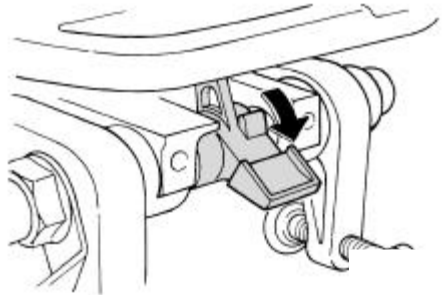

3. Slightly tilt the outboard motor up. The tilt support bar will lock automatically, supporting the outboard motor in a partially raised position. This outboard motor has 2 positions for shallow water cruising.

# Operation

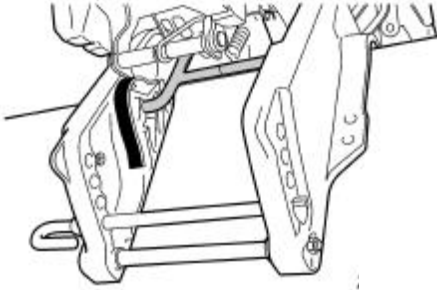

4. To return the outboard motor to the normal running position, place the remote control lever / gear shift lever in neutral.
5. Place the tilt lock lever in the lock/down position, then slightly tilt the outboard motor up until the tilt support bar automatically returns to the free position.

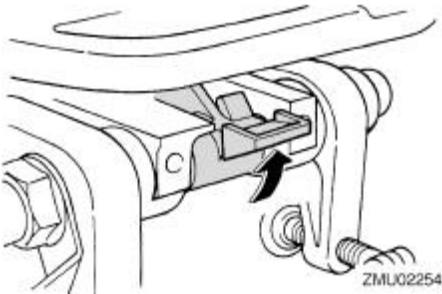

6. Slowly lower the outboard motor to the normal position.

## Power tilt models

The outboard motor can be tilted up partially to allow operation in shallow water.

### NOTICE

Do not tilt the outboard motor up so that the cooling water inlet on the lower unit is above the surface of the water when setting up for and cruising in shallow water. Otherwise severe damage from overheating can result.

## Procedure for power tilt models

1. Place the remote control lever in neutral.

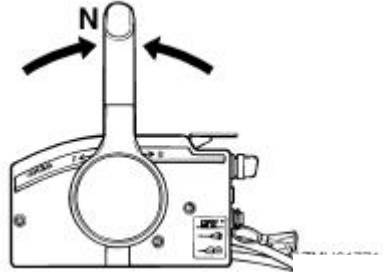

2. Slightly tilt the outboard motor up to the desired position using the power tilt switch. **WARNING! Using the power tilt switch on the bottom cowling while the boat is moving or engine is on could increase the risk of falling overboard and could distract the operator, increasing the risk of collision with another boat or an obstacle.**

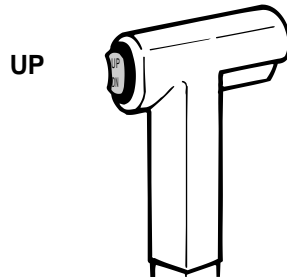

3. To return the outboard motor to the normal running position, press the power tilt switch and slowly tilt the outboard motor down.

## **Cruising in other conditions**

### **Cruising in salt water**

After operating in salt water, flush the cooling water passages with fresh water to prevent them from becoming clogged. Also rinse the outside of the outboard motor with fresh water.

### **Cruising in muddy, turbid, or acidic water**

Outboards strongly recommends that you use the optional chromium-plated water pump kit (see page 14) if you use the outboard motor in acidic water or water with a lot of sediment in it, such as muddy or turbid (cloudy) water. After operating in such water, flush the cooling passages with fresh water to prevent corrosion. Also rinse the outside of the outboard motor with fresh water.

# Maintenance

## Transporting and storing outboard motor

- ⦿ **USE CARE** when transporting fuel tank, whether in a boat or car.
- ⦿ **DO NOT** fill fuel container to maximum capacity. Gasoline will expand considerably as it warms up and can build up pressure in the fuel container. This can cause fuel leakage and a potential fire hazard.
- ⦿ **Leaking fuel is a fire hazard.** When transporting and storing the outboard motor, disconnect the fuel line from the outboard motor to prevent fuel from leaking.
- ⦿ **Never get under the outboard motor** while it is tilted. Severe injury could occur if the outboard motor accidentally falls.
- ⦿ **Do not use the tilt support lever or knob** when trailering the boat. The outboard motor could shake loose from the tilt support and fall. If the outboard motor cannot be trailered in the normal running position, use an additional support device to secure it in the tilt position.

### **NOTICE**

When storing the outboard motor for prolonged time, fuel must be drained from the fuel tank. The deteriorated fuel could clog the fuel line causing engine start difficulty or malfunction.

When storing or transporting the outboard motor, make sure to follow the procedure listed below.

- ⦿ Disconnect the fuel line from the outboard motor.
- ⦿ Tighten the fuel tank cap and its air vent screw.
- ⦿ When the outboard motor is tilted prolonged time for mooring or trailering the boat, disconnect the fuel line from the outboard motor. Tighten the fuel tank cap and its air vent screw.

The outboard motor should be transported and stored in the normal running position. If there is insufficient road clearance in this position, then trailer the outboard motor in the tilt position using a motor support device such as a transom saver bar. Consult your Outboards dealer for further details.

## Dismounting the outboard motor

### **NOTICE**

**Do not hold the top cowling when mounting or dismounting the outboard motor. The top cowling could come off, causing the outboard motor to fall.**

1. Stop the engine and land the boat.
2. Disconnect the fuel line from the outboard motor.

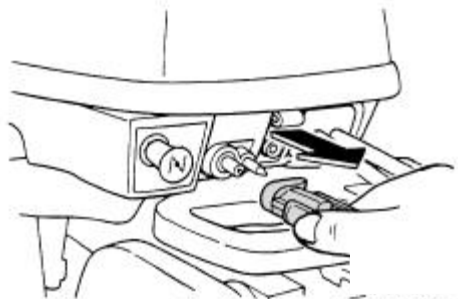

3. For electric start models, disconnect the battery cables from the battery terminals.

# Maintenance

4. To prevent steering movement, turn the adjuster lever to "A" (if equipped with the adjuster lever). To hold the steering bracket easily, raise the tiller handle to the vertical position (if equipped with the tiller handle).

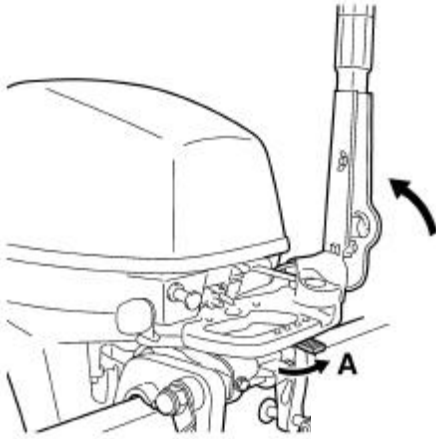

5. Loosen the clamp screw(s).
6. Hold the handgrip and steering bracket as shown in the illustration and lift up the outboard motor to dismount it from the boat.

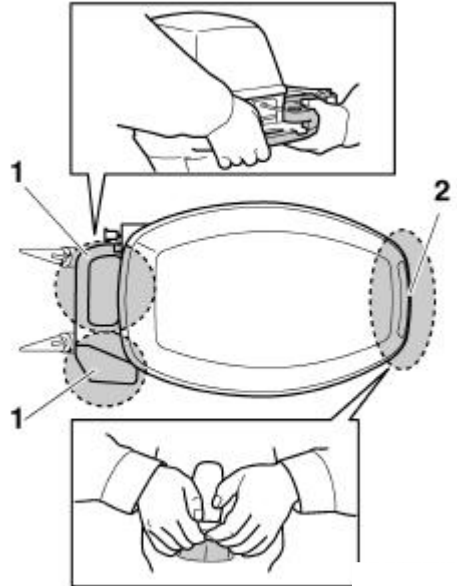

1. Steering bracket
2. Handgrip

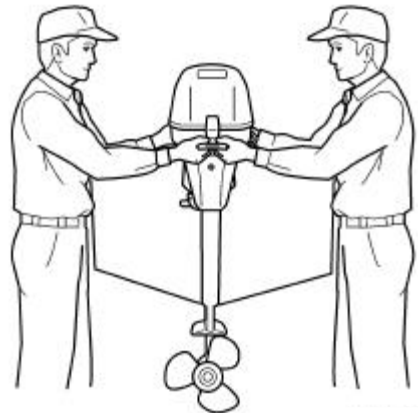

7. board motor while removed from a boat, keep the outboard motor in the attitude shown or use an outboard motor stand.

# Maintenance

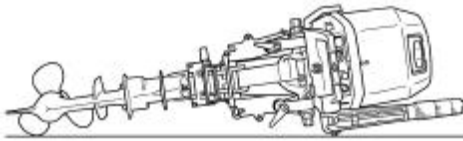
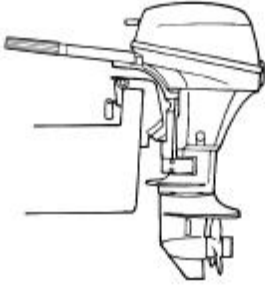

## TIP:

When transporting the outboard motor in a horizontal position, place a towel or something similar under the outboard motor to protect it from damage.

## Storing outboard motor

When storing your Outboards outboard motor for prolonged periods of time (2 months or longer), several important procedures must be performed to prevent excessive damage. It is advisable to have your outboard motor serviced by an authorized Outboards dealer prior to storage. However, you, the owner, with a minimum of tools, can perform the following procedures.

## NOTICE

⚠ **To prevent problems which can be caused by oil entering the cylinder from the sump, keep the outboard motor in**

the attitude shown when transporting and storing it. If storing or transporting the outboard motor on its side (not upright), put it on a cushion after draining the engine oil.

- ⚠ **Do not place the outboard motor on its side before the cooling water has drained from it completely, otherwise water may enter the cylinder through the exhaust port and cause engine trouble.**
- ⚠ **Store the outboard motor in a dry, well-ventilated place, not in direct sunlight.**

## Procedure

### Flushing in a test tank

## NOTICE

**Before starting the engine, make sure to supply water to the cooling water passages. Otherwise, the engine could overheat and be damaged.**

1. Dismount the outboard motor from the boat. For further details, see page 56.
2. Wash the outboard motor body using fresh water. **NOTICE: Do not spray water into the air intake.**<sup>[ECM01840]</sup> For further information, see page 60.
3. Disconnect the fuel line from the outboard motor.
4. Remove the engine top cowling and silencer cover/cap, if equipped. Remove the propeller. For further details, see page 71.
5. Position the outboard motor on a water tank. For further details, see page 29.
6. Fill the tank with fresh water until the anti-cavitation plate is immersed in water. **NOTICE: If the fresh water level is below the level of the anti-cavitation**



plate, or if the water supply is insufficient, engine seizure may occur.

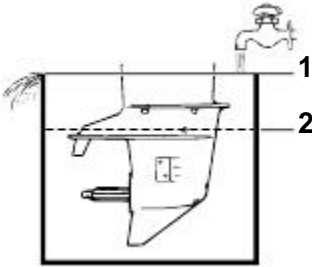

1. Water surface
  2. Lowest water level
7. Cooling system flushing is essential to prevent the cooling system from clogging up with salt, sand, or dirt. In addition, fogging/lubricating of the engine is mandatory to prevent excessive engine damage due to rust. Perform the flushing and fogging at the same time. **WARNING! Do not touch or remove electrical parts when starting or during operation. Keep hands, hair, and clothes away from the flywheel and other rotating parts while the engine is running.**
  8. Run the engine at a fast idle for a few minutes in neutral position.
  9. Just prior to turning off the engine, quickly spray "Fogging Oil" alternately into each carburetor or the fogging hole of the silencer cover, if equipped. When properly done, the engine will smoke excessively and almost stall.
  10. Remove the outboard motor from the test tank.
  11. Install the silencer cover/cap of fogging hole (if equipped) and top cowling.

12. If the "Fogging Oil" is not available, run the engine at a fast idle until the fuel system becomes empty and the engine stops.
13. Drain the cooling water completely out of the motor. Clean the body thoroughly.
14. If the "Fogging Oil" is not available, remove the spark plug(s). Pour a teaspoonful of clean engine oil into each cylinder. Crank several times manually. Replace the spark plug(s).
15. Drain the fuel from the fuel tank.
16. Store the fuel tank in a dry, well-ventilated place, not in direct sunlight.

## Lubrication

1. Install the spark plug(s) and torque to proper specification. For information on spark plug installation, see page 67.
2. Change the gear oil. For instructions, see page 72. Inspect the oil for the presence of water that indicates a leaky seal. Seal replacement should be performed by an authorized Outboards dealer prior to use.
3. Grease all grease fittings. For further details, see page 65.

## TIP:

For long-term storage, fogging the engine with oil is recommended. Contact your Outboards dealer for information about fogging oil and procedures for your engine.

## Flushing power unit

Perform this procedure right after operation for the most thorough flushing.

## NOTICE

**Do not perform this procedure while the engine is running. The water pump may be damaged and severe damage from overheating can result.**

# Maintenance

1. After shutting off the engine, unscrew the garden hose connector from the fitting on the bottom cowling.

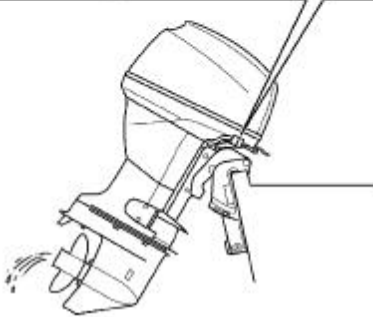
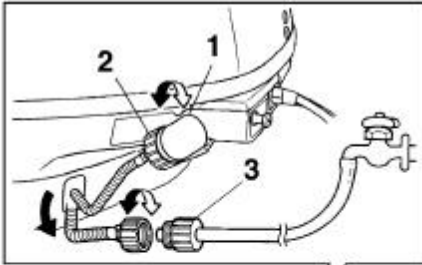

1. Fitting
2. Garden hose connector
3. Garden hose adapter

2. Screw the garden hose adapter onto a garden hose, which is connected to a fresh water supply, and then connect it to the garden hose connector.
3. With the engine off, turn on the water tap and let the water flush through the cooling passages for about 15 minutes. Turn off the water and disconnect the garden hose adapter from the garden hose connector.
4. Reinstall the garden hose connector onto the fitting on the bottom cowling. Tighten the connector securely. **NOTICE: Do not leave the garden hose connector loose on the bottom cowling fitting or let the hose hang free during normal**

**operation. Water will leak out of the connector instead of cooling the engine, which can cause serious overheating. Be sure the connector is tightened securely on the fitting after flushing the engine.**

## TIP:

- When flushing the engine with the boat in the water, tilting up the outboard motor until it is completely out of the water will achieve better results.
- For cooling system flushing instructions, see page 56.

## Cleaning the outboard motor

After use, wash the exterior of the outboard motor with fresh water. Flush the cooling system with fresh water.



## Checking painted surface of outboard motor

Check the outboard motor for scratches, nicks, or flaking paint. Areas with damaged paint are more likely to corrode. If necessary, clean and paint the areas. A touch-up paint is available from your Outboards dealer.

## Periodic maintenance

**These procedures require mechanical skills, tools, and supplies. If you do not have the proper skills, tools, or supplies to perform a maintenance procedure, have a Outboards dealer or other qualified mechanic do the work.**

**The procedures involve disassembling the motor and exposing dangerous parts. To reduce the risk of injury from moving, hot, or electrical parts:**

- ⦿ **Turn off the engine and keep the key(s) and engine shut-off cord (lanyard) with you when you perform maintenance unless otherwise specified.**
- ⦿ **The power tilt switch operate even when the ignition key is off. Keep people away from the switches whenever working around the motor. When the motor is tilted, keep away from the area under it or between it and the clamp bracket. Be sure no one is in this area before operating the power tilt mechanism.**
- ⦿ **Allow the engine to cool before handling hot parts or fluids.**
- ⦿ **Always completely reassemble the motor before operation.**

## Replacement parts

If replacement parts are necessary, use only genuine Outboards parts or parts of equivalent design and quality. Any part of inferior quality may malfunction, and the resulting loss of control could endanger the operator and passengers. Outboards genuine parts and accessories are available from your Outboards dealer.

## Severe operating conditions

Severe operating conditions involve one or more of the following types of operation on a regular basis:

- ⦿ Operating continuously at or near maximum engine speed (rpm) for many hours
- ⦿ Operating continuously at a low engine speed (rpm) for many hours
- ⦿ Operating without sufficient time for engine to warm up and cool down
- ⦿ Frequent quick acceleration and deceleration
- ⦿ Frequent shifting
- ⦿ Frequently starting and stopping the engine(s)
- ⦿ Operation that fluctuates often between light and heavy cargo loads

Outboard motors operating under any of these above conditions require more frequent maintenance. Outboards recommends that you do this service twice as often as specified in the maintenance chart. For example, if a particular service should be done at 50 hours, do it instead at 25 hours. This will help prevent more rapid deterioration of engine components.

# Maintenance

## Maintenance chart 1

### TIP:

- ☞ Refer to the sections in this chapter for explanations of each owner-specific action.
  - ☞ The maintenance cycle on these charts assume usage of 100 hours per year and regular flushing of the cooling water passages. Maintenance frequency should be adjusted when operating the engine under adverse conditions such as extended trolling.
  - ☞ Disassembly or repairs may be necessary depending on the outcome of maintenance checks.
  - ☞ Expendable or consumable parts and lubricants will lose their effectiveness over time and through normal usage regardless of the warranty period.
  - ☞ When operating in salt water, muddy, other turbid (cloudy), acidic water, the engine should be flushed with clean water after each use.
- The “ ” symbol indicates the check-ups which you may carry out yourself.

Item	Actions	Initial	Every		
		20 hours (3 months)	100 hours (1 year)	300 hours (3 years)	500 hours (5 years)
Anode(s) (external)	Inspection or replacement as necessary				
Anode(s) (cylinder head, thermostat cover)	Inspection or replacement as necessary				
Anodes (exhaust cover, cooling water passage cover, Rectifier Regulator cover)	Replacement				
Battery (electrolyte level, terminal)	Inspection				
Battery (electrolyte level, terminal)	Fill, charging or replacing as necessary				
Cooling water leakage	Inspection or replacement as necessary				
Cowling lock lever	Inspection				
Engine starting condition/noise	Inspection				
Engine idle speed/noise	Inspection				
Engine oil	Replacement				
Engine oil filter (built into oil pan)	Inspection, cleaning or replacement as necessary				
Fuel filter (disposal type)	Replacement				

# Maintenance

Item	Actions	Initial	Every		
		20 hours (3 months)	100 hours (1 year)	300 hours (3 years)	500 hours (5 years)
Fuel line (High pressure)	Inspection				
Fuel line (High pressure)	Inspection or replacement as necessary				
Fuel line (Low pressure)	Inspection				
Fuel line (Low pressure)	Inspection or replacement as necessary				
Fuel pump	Inspection or replacement as necessary				
Fuel/engine oil leakage	Inspection				
Gear oil	Replacement				
Greasing points	Greasing				
Impeller/water pump housing	Inspection or replacement as necessary				
Impeller/water pump housing	Replacement				
Power trim and tilt unit	Inspection				
Propeller/propeller nut/cotter pin	Inspection or replacement as necessary				
Shift link/shift cable	Inspection, adjustment or replacement as necessary				
Spark plug(s)	Inspection or replacement as necessary				
Spark plug caps/spark plug wires	Inspection or replacement as necessary				
Water from the cooling water pilot hole	Inspection				
Throttle link/throttle cable/throttle pick-up timing	Inspection, adjustment or replacement as necessary				
Thermostat	Inspection or replacement as necessary				
Timing belt	Inspection or replacement as necessary				
Valve clearance	Inspection and adjustment				
Cooling water inlet	Inspection				
Main switch/stop switch/choke switch	Inspection or replacement as necessary				

# Maintenance

Item	Actions	Initial	Every		
		20 hours (3 months)	100 hours (1 year)	300 hours (3 years)	500 hours (5 years)
Wire harness connections/wire coupler connections	Inspection or replacement as necessary				
Fuel tank (Outboards portable tank)	Inspection and cleaning as necessary				

## Maintenance chart 2

Item	Actions	Every
		1000 hours
Exhaust guide/exhaust manifold	Inspection or replacement as necessary	
Timing belt	Replacement	

## Greasing

Outboards grease A (water resistant grease)

Outboards grease D (corrosion resistant grease; for propeller shaft)

FPP8A; FPP9.9A

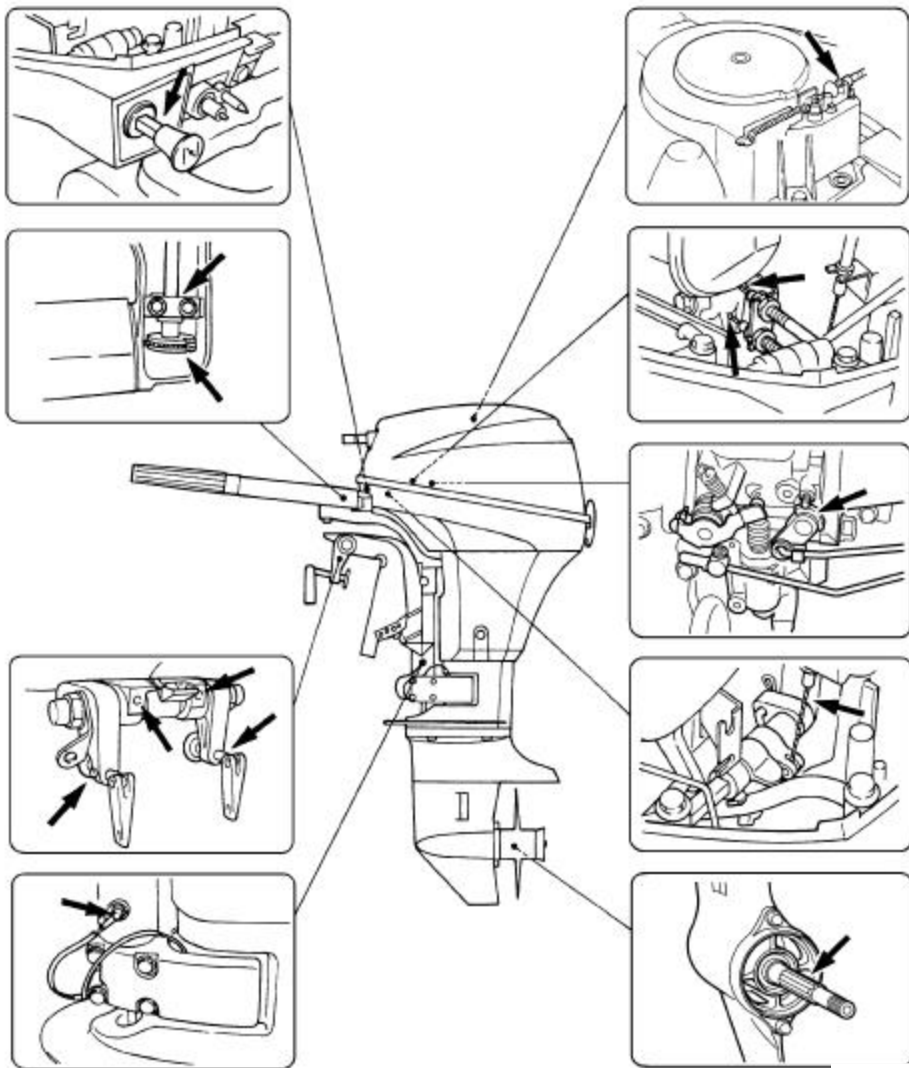

# Maintenance

FPW8A; FPW9.9A

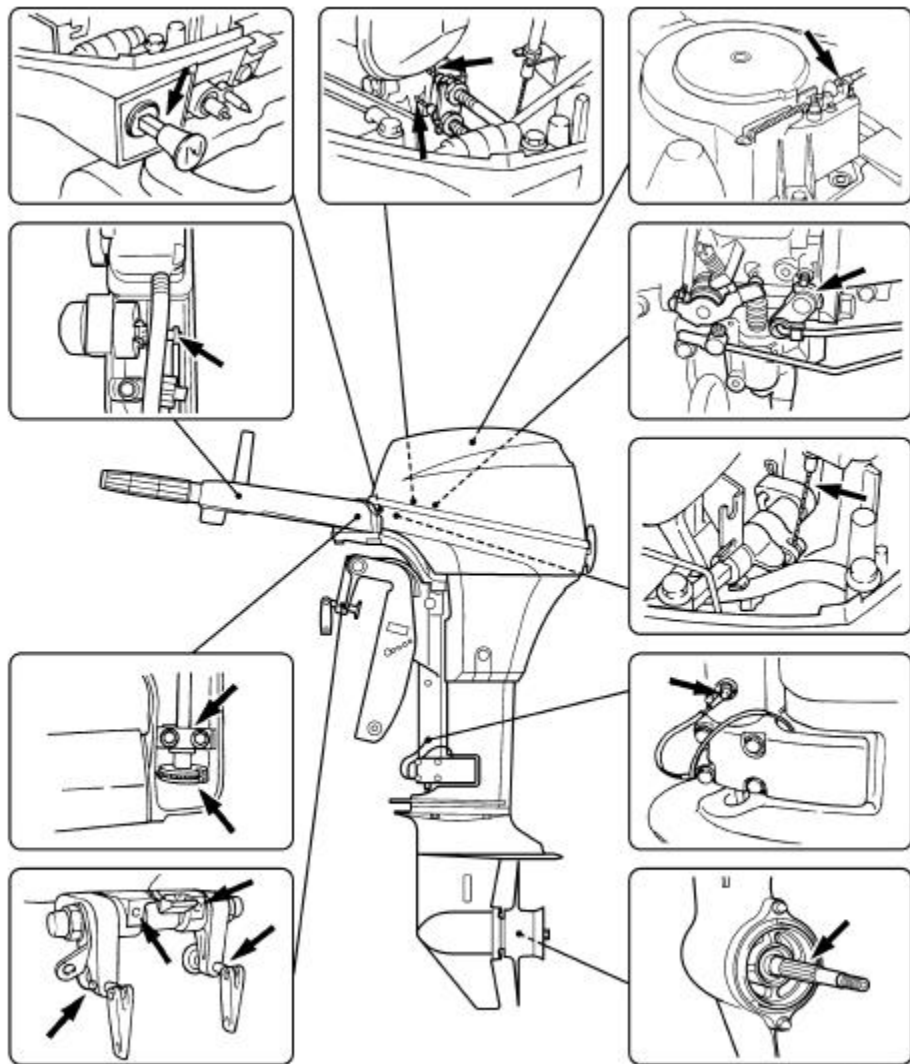



## Cleaning and adjusting spark plug

The spark plug is an important engine component and is easy to inspect. The condition of the spark plug can indicate something about the condition of the engine. For example, if the center electrode porcelain is very white, this could indicate an intake air leak or carburetion problem in that cylinder. Do not attempt to diagnose any problems yourself. Instead, take the outboard motor to a Outboards dealer. You should periodically remove and inspect the spark plug because heat and deposits will cause the spark plug to slowly break down and erode.

1. Remove the spark plug caps from the spark plugs.
2. Remove the spark plug. If electrode erosion becomes excessive, or if carbon and other deposits are excessive, you should replace the spark plug with another of the correct type. **WARNING! When removing or installing a spark plug, be careful not to damage the insulator. A damaged insulator could allow external sparks, which could lead to explosion or fire.**

Standard spark plug:  
BR6HS-10

3. Be sure to use the specified spark plug, otherwise the engine may not operate properly. Before fitting the spark plug, measure the electrode gap with a wire thickness gauge; replace it if out of specification.

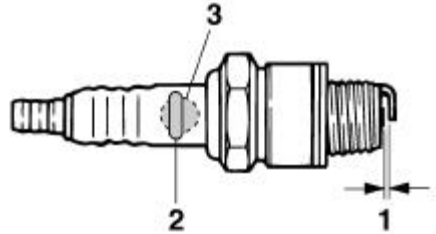

1. Spark plug gap
2. Spark plug part number
3. Spark plug I.D. mark (NGK)

Spark plug gap:  
0.9–1.0 mm (0.035–0.039 in)

4. When fitting the plug, wipe off any dirt from the threads, and then screw it in to the correct torque.

Spark plug torque:  
25.0 Nm (2.55 kgf-m, 18.4 ft-lb)

### TIP:

If a torque-wrench is not available when you are fitting a spark plug, a good estimate of the correct torque is 1/4 to 1/2 a turn past finger-tight. Have the spark plug adjusted to the correct torque as soon as possible with a torque-wrench.

EMU28991

### Checking fuel filter

Check the fuel filter periodically. The fuel filter is a one piece, disposable type. If foreign matter is found in the filter, replace it. For replacement of the fuel filter, consult your Outboards dealer.

# Maintenance

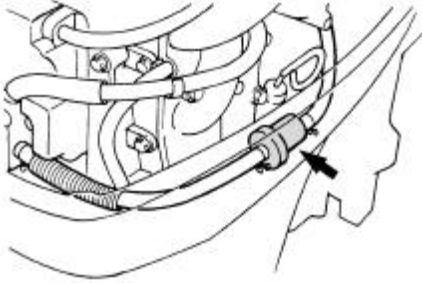

## Inspecting idle speed

- ⚠ Do not touch or remove electrical parts when starting or during operation.
- ⚠ Keep hands, hair, and clothes away from the flywheel and other rotating parts while the engine is running.

### **NOTICE**

This procedure must be performed while the outboard motor is in the water. A flushing attachment or test tank can be used.

If the boat is not equipped with a tachometer for the outboard motor, use a diagnostic tachometer for this procedure. Results may vary depending on whether testing is conducted with the flushing attachment, in a test tank, or with the outboard motor in the water.

1. Start the engine and allow it to warm up fully in neutral until it is running smoothly.
2. Once the engine has warmed up, verify whether the idle speed is set to specification. For idle speed specifications, see page 10. If you have difficulty verifying the idle speed, or the idle speed requires adjustment, consult a Outboards dealer or other qualified mechanic.

## Changing engine oil

### **NOTICE**

Change the engine oil after the first 20 hours of operation or 3 months, and every 100 hours or at 1-year intervals thereafter. Otherwise the engine will wear quickly.

Extract the engine oil with an oil changer.

1.

sition (not tilted). **NOTICE:** If the outboard motor is not level, the oil level indicated on the oil dipstick may not be accurate. [ECM01861]

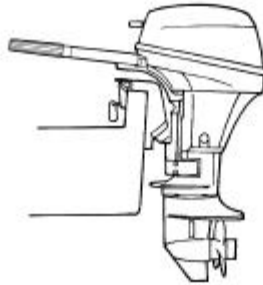

2. Start the engine. Warm it up and keep the idle speed for 5-10 minutes.
3. Stop the engine and leave it for 5-10 minutes.
4. Remove the top cowling.
5. Remove the oil filler cap. Pull out the dipstick and use the oil changer to extract the oil completely.

# Maintenance

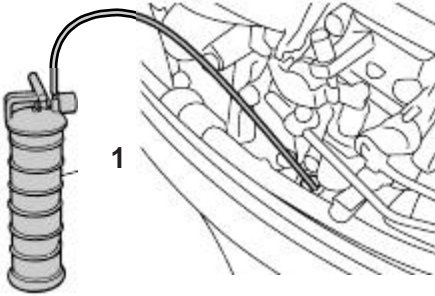

1. Oil changer

## TIP:

If the oil changer is not available, remove the drain screw while holding a container under the drain hole. Let the oil drain completely. Wipe up any spilled oil immediately.

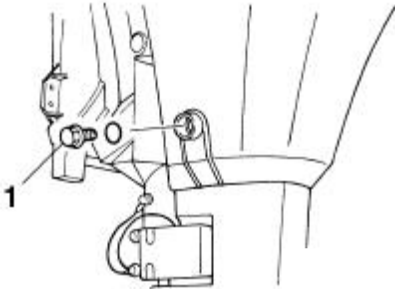

1. Drain screw

6. Add the correct amount of oil through the filler hole. Put back the filler cap and the dipstick. **NOTICE: Overfilling the oil could cause leakage or damage. If the oil level is above the upper level mark, drain until the level meets the specified capacity.**

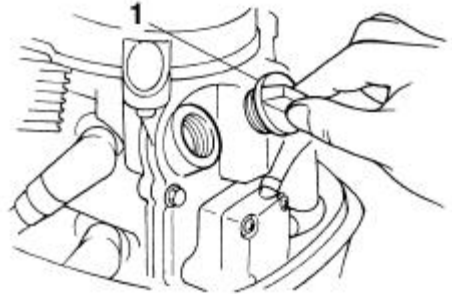

1. Oil filler cap

Recommended engine oil:

4-stroke outboard motor oil

Engine oil quantity:

0.8 L (0.85 US qt, 0.70 Imp.qt)

7. Leave the outboard motor for 5-10 minutes.
8. Remove oil dipstick and wipe it clean.
9. Insert the dipstick and remove it again. Be sure to completely insert the dipstick into the dipstick guide, otherwise the oil level measurement will be incorrect.
10. Recheck the oil level using the dipstick to be sure the level falls between the upper and lower marks. Consult your Outboards dealer if the oil level is out of specified level.

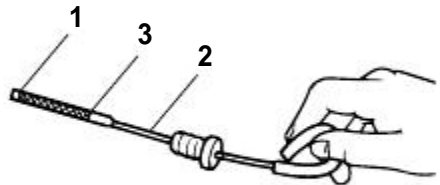

1. Lower level mark
2. Oil dipstick
3. Upper level mark

# Maintenance

11. Start the engine and make sure that the low oil pressure-alert indicator remains off. Also, make sure that there are no oil leaks. **NOTICE: If the low oil pressure-alert indicator comes on or if there are oil leaks, stop the engine and find the cause. Continued operation with a problem could cause severe engine damage. Consult your Outboards dealer if the problem cannot be located and corrected.**
12. Dispose of used oil according to local regulations.

## TIP:

- ⦿ For more information on the disposal of used oil, consult your Outboards dealer.
- ⦿ Change the oil more often when operating the engine under adverse conditions such as extended trolling.

## Inspecting wiring and connectors

- ⦿ Inspect that each connector is engaged securely.
- ⦿ Inspect that each ground lead is properly secured.

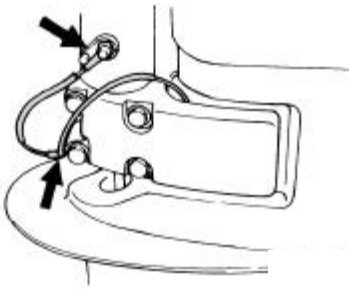

## Checking propeller

You could be seriously injured if the engine accidentally starts when you are near the propeller. Before inspecting, remov-

ing, or installing the propeller, place the shift control in neutral, turn the main switch to “**0**” (off) and remove the key, and remove the clip from the engine shut-off switch. Turn off the battery cut-off switch if your boat has one.

Do not use your hand to hold the propeller when loosening or tightening the propeller nut. Put a wood block between the anti-cavitation plate and the propeller to prevent the propeller from turning.

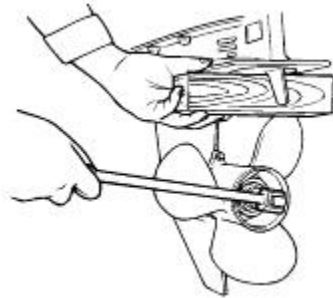

## Checkpoints

- ⦿ Check each of the propeller blades for erosion from cavitation or ventilation, or other damage.
- ⦿ Check the propeller shaft for damage.
- ⦿ Check the splines for wear or damage.
- ⦿ Check for fish line tangled around the propeller shaft.

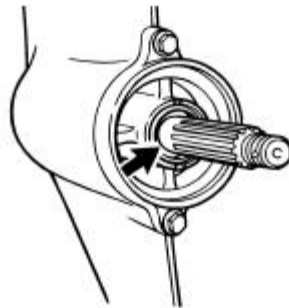

# Maintenance

- Check the propeller shaft oil seal for damage.

## Removing propeller

### Spline models

1. Straighten the cotter pin and pull it out using a pair of pliers.
2. Remove the propeller nut, washer, and spacer (if equipped). **WARNING! Do not use your hand to hold the propeller when loosening the propeller nut.**

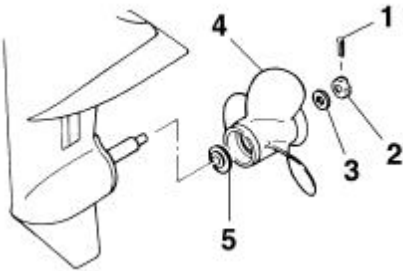

1. Cotter pin
2. Propeller nut
3. Washer
4. Propeller
5. Thrust washer

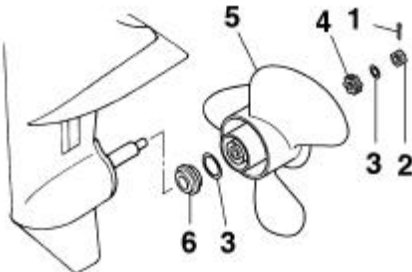

1. Cotter pin
2. Propeller nut
3. Washer
4. Spacer
5. Propeller

6. Thrust washer
3. Remove the propeller, washer (if equipped), and thrust washer.

## Installing propeller

### Spline models

### NOTICE

**Make sure to use a new cotter pin and bend the ends over securely. Otherwise, the propeller could come off during operation and be lost.**

1. Apply Outboards marine grease or a corrosion resistant grease to the propeller shaft.
2. Install the spacer (if equipped), thrust washer, washer (if equipped), and propeller on the propeller shaft. **NOTICE: Make sure to install the thrust washer before installing the propeller. Otherwise, the lower case and propeller boss could be damaged.**
3. Install the spacer (if equipped) and the washer. Tighten the propeller nut to the specified torque.

### Propeller nut tightening torque:

- FPP(8/9.9)AER 17.0 Nm (1.73 kgf-m, 12.5 ft-lb)
- FPP(8/9.9)AMH 17.0 Nm (1.73 kgf-m, 12.5 ft-lb)
- FPW(8/9.9)AER 21.0 Nm (2.14 kgf-m, 15.5 ft-lb)
- FPW(8/9.9)AMH 21.0 Nm (2.14 kgf-m, 15.5 ft-lb)

4. Align the propeller nut with the propeller shaft hole. Insert a new cotter pin in the hole and bend the cotter pin ends.

# Maintenance

**NOTICE:** Do not reuse the cotter pin. Otherwise, the propeller can come off during operation.

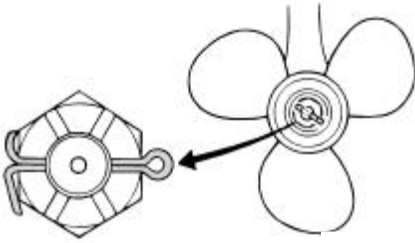

## TIP:

If the propeller nut does not align with the propeller shaft hole after tightening to the specified torque, tighten the nut further to align it with the hole.

## Changing gear oil

- ⚠ **Be sure the outboard motor is securely fastened to the transom or a stable stand. You could be severely injured if the outboard motor falls on you.**
- ⚠ **Never get under the lower unit while it is tilted, even when the tilt support lever or knob is locked. Severe injury could occur if the outboard motor accidentally falls.**

1. Tilt the outboard motor so that the gear oil drain screw is at the lowest point possible.
2. Place a suitable container under the gear case.
3. Remove the gear oil drain screw and gasket. **NOTICE: If there is an excessive quantity of metal particles on the mag-**

**netic gear oil drain screw, this can indicate lower unit problem. Consult your Outboards dealer.**

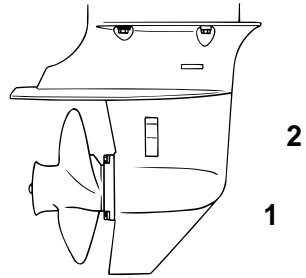

1. Gear oil drain screw
2. Oil level plug

## TIP:

- ⚠ If a magnetic gear oil drain screw is equipped, remove all metal particles from the screw before installing it.
  - ⚠ Always use new gaskets. Do not reuse the removed gaskets.
4. Remove the oil level plug and gasket to allow the oil to drain completely. **NOTICE: Check the used gear oil after it has been drained. If the gear oil is milky or contains water or a large amount of metal particles, the gear case may be damaged. Have a Outboards dealer check and repair the outboard motor.** [ECM00713]

## TIP:

For disposal of used oil, consult your Outboards dealer.

5. Put the outboard motor in a vertical position. Using a flexible or pressurized filling device, inject the gear oil into the gear oil drain screw hole.

Recommended gear oil:

Hypoid gear oil SAE#90

Gear oil quantity:

FPP(8/9.9)AER 0.150 L (0.159 US qt,  
0.132 Imp.qt)

FPP(8/9.9)AMH 0.150 L (0.159 US qt,  
0.132 Imp.qt)

FPW9.9AER 0.370 L (0.391 US qt,  
0.326 Imp.qt)

FPW(8/9.9)AMH 0.370 L (0.391 US qt,  
0.326 Imp.qt)

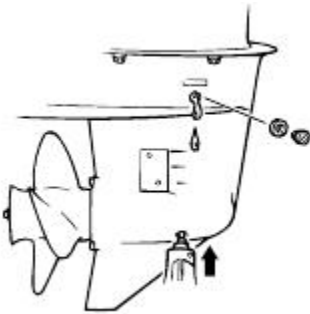

6. Put a new gasket on the oil level plug. When the oil begins to flow out of the oil level plug hole, insert and tighten the oil level plug.

Tightening torque:

9.0 Nm (0.92 kgf-m, 6.6 ft-lb)

7. Put a new gasket on the gear oil drain screw. Insert and tighten the gear oil drain screw.

Tightening torque:

9.0 Nm (0.92 kgf-m, 6.6 ft-lb)

## Cleaning fuel tank

**Gasoline is highly flammable, and its vapors are flammable and explosive.**

- ⓘ **If you have any question about properly doing this procedure, consult your Outboards dealer.**
- ⓘ **Keep away from sparks, cigarettes, flames, or other sources of ignition when cleaning the fuel tank.**
- ⓘ **Remove the fuel tank from the boat before cleaning it. Work only outdoors in an area with good ventilation.**
- ⓘ **Wipe up any spilled fuel immediately.**
- ⓘ **Reassemble the fuel tank carefully. Improper assembly can result in a fuel leak, which could result in a fire or explosion hazard.**
- ⓘ **Dispose of old gasoline according to local regulations.**

1. Empty the fuel tank into an approved container.
2. Pour a small amount of suitable solvent into the tank. Install the cap and shake the tank. Drain the solvent completely.

# Maintenance

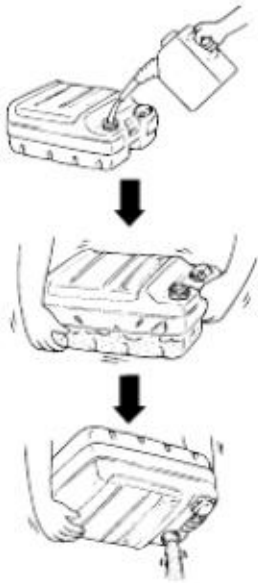

3. Remove the screws holding the fuel joint assembly. Pull the assembly out of the tank.

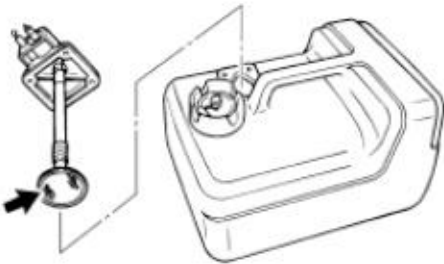

4. Clean the filter (located on the end of the suction pipe) in a suitable cleaning solvent. Allow the filter to dry.
5. Replace the gasket with a new one. Reinstall the fuel joint assembly and tighten the screws firmly.

## Inspecting and replacing anode(s)

Outboards outboard motors are protected from corrosion by sacrificial anodes. Inspect the external anodes periodically. Remove scales from the surfaces of the anodes. Consult a Outboards dealer for replacement of external anodes.

### **NOTICE**

**Do not paint anodes, as this would render them ineffective.**

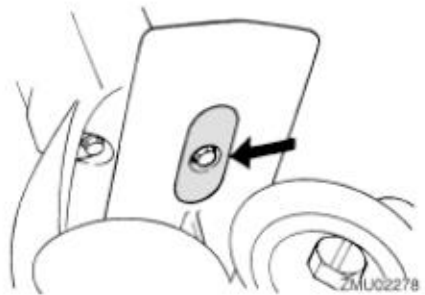
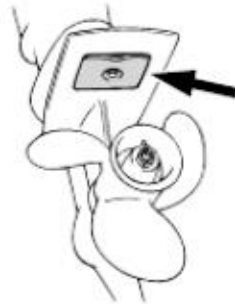



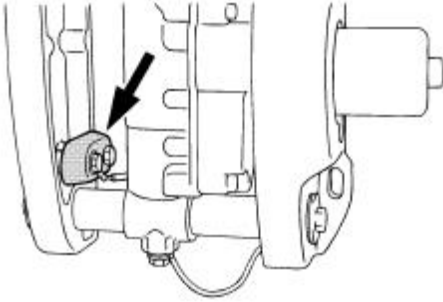

## TIP:

Inspect ground leads attached to external anodes on equipped models. Consult a Outboards dealer for inspection and replacement of internal anodes attached to the power unit.

## Checking battery (for electric start models)

Battery electrolyte is poisonous and caustic, and batteries generate explosive hydrogen gas. When working near the battery:

- Wear protective eye gear and rubber gloves.
- Do not smoke or bring any other source of ignition near the battery.

The procedure for checking the battery varies for different batteries. This procedure contains typical checks that apply to many batteries, but you should always refer to the battery manufacturer's instructions.

## NOTICE

**A poorly maintained battery will quickly deteriorate.**

1. Check the electrolyte level.

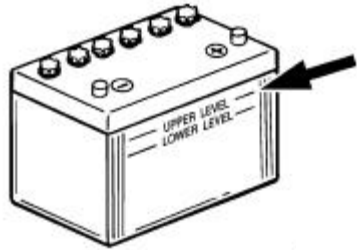

2. Check the battery's charge. If your boat is equipped with the digital speedometer, the voltmeter and low battery alert functions will help you monitor the battery's charge. If the battery needs charging, consult your Outboards dealer.
3. Check the battery connections. They should be clean, secure, and covered by an insulating cover. **WARNING! Bad connections can produce shorting or arcing and cause an explosion.**

## Connecting the battery

Mount the battery holder securely in a dry, well-ventilated, vibration-free location in the boat. Install a fully charged battery in the holder.

## NOTICE

**Do not reverse the battery cables. Otherwise, the electrical parts could be damaged.**

1. Make sure the main switch (on applicable models) is "O" (off) before working on the battery.
2. Connect the red battery cable to the POSITIVE (+) terminal first. Then connect the black battery cable to the NEGATIVE (-) terminal.

# Maintenance

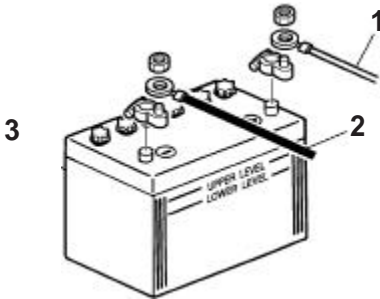

1. Red cable
2. Black cable
3. Battery

3. The electrical contacts of the battery and cables must be clean and properly connected, or the battery will not start the engine.

## Disconnecting the battery

1. Turn off the battery cut-off switch (if equipped) and main switch. **NOTICE: If they are left on, the electrical system can be damaged.**
2. Disconnect the negative cable(s) from the negative (-) terminal. **NOTICE: Always disconnect all negative (-) cables first to avoid a short circuit and damage to the electrical system.**
3. Disconnect the positive cable(s) and remove the battery from the boat.
4. Clean, maintain, and store the battery according to the manufacturer's instructions.

# Trouble Recovery

## Troubleshooting

A problem in the fuel, compression, or ignition systems can cause poor starting, loss of power, or other problems. This section describes basic checks and possible remedies, and covers all Outboards outboard motors. Therefore some items may not apply to your model. If your outboard motor requires repair, bring it to your Outboards dealer. If the engine trouble-alert indicator is flashing, consult your Outboards dealer.

### **Starter will not operate.**

- Q. Is battery capacity weak or low?  
A. Check battery condition. Use battery of recommended capacity.
- Q. Are battery connections loose or corroded?  
A. Tighten battery cables and clean battery terminals.
- Q. Is fuse for electric start relay or electric circuit blown?  
A. Check for cause of electric overload and repair. Replace fuse with one of correct amperage.
- Q. Are starter components faulty?  
A. Have serviced by a Outboards dealer.
- Q. Is shift lever in gear?  
A. Shift to neutral.
- Engine will not start (starter operates).**
- Q. Is fuel tank empty?  
A. Fill tank with clean, fresh fuel.
- Q. Is fuel contaminated or stale?  
A. Fill tank with clean, fresh fuel.

- Q. Is fuel filter clogged?  
A. Clean or replace filter.
- Q. Is starting procedure incorrect?  
A. See page 38.
- Q. Has fuel pump malfunctioned?  
A. Have serviced by a Outboards dealer.
- Q. Are spark plug(s) fouled or of incorrect type?  
A. Inspect spark plug(s). Clean or replace with recommended type.
- Q. Are spark plug cap(s) fitted incorrectly?  
A. Check and re-fit cap(s).
- Q. Is ignition wiring damaged or poorly connected?  
A. Check wires for wear or breaks. Tighten all loose connections. Replace worn or broken wires.
- Q. Are ignition parts faulty?  
A. Have serviced by a Outboards dealer.
- Q. Is engine shut-off cord (lanyard) not attached?  
A. Attach cord.
- Q. Are engine inner parts damaged?  
A. Have serviced by a Outboards dealer.
- Engine idles irregularly or stalls.**
- Q. Are spark plug(s) fouled or of incorrect type?  
A. Inspect spark plug(s). Clean or replace with recommended type.
- Q. Is fuel system obstructed?

# Trouble Recovery

A. Check for pinched or kinked fuel line or other obstructions in fuel system.

Q. Is fuel contaminated or stale?

A. Fill tank with clean, fresh fuel.

Q. Is fuel filter clogged?

A. Clean or replace filter.

Q. Have ignition parts failed?

A. Have serviced by a Outboards dealer.

Q. Has alert system activated?

A. Find and correct cause of alert.

Q. Is spark plug gap incorrect?

A. Inspect and adjust as specified.

Q. Is ignition wiring damaged or poorly connected?

A. Check wires for wear or breaks. Tighten all loose connections. Replace worn or broken wires.

Q. Is specified engine oil not being used?

A. Check and replace oil as specified.

Q. Is thermostat faulty or clogged?

A. Have serviced by a Outboards dealer.

Q. Are carburetor adjustments incorrect?

A. Have serviced by a Outboards dealer.

Q. Is fuel pump damaged?

A. Have serviced by a Outboards dealer.

Q. Is air vent screw on fuel tank closed?

A. Open air vent screw.

Q. Is choke knob pulled out?

A. Return to home position.

Q. Is motor angle too high?

A. Return to normal operating position.

Q. Is carburetor clogged?

A. Have serviced by a Outboards dealer.

Q. Is fuel joint connection incorrect?

A. Connect correctly.

Q. Is throttle valve adjustment incorrect?

A. Have serviced by a Outboards dealer.

Q. Is battery cable disconnected?

A. Connect securely.

## **Alert buzzer sounds or indicator lights.**

Q. Is cooling system clogged?

A. Check water intake for restriction.

Q. Is engine oil level low?

A. Fill oil tank with specified engine oil.

Q. Is heat range of spark plug incorrect?

A. Inspect spark plug and replace it with recommended type.

Q. Is specified engine oil not being used?

A. Check and replace oil with specified type.

Q. Is engine oil contaminated or deteriorated?

A. Replace oil with fresh, specified type.

Q. Is oil filter clogged?

A. Have serviced by a Outboards dealer.

Q. Has oil feed/injection pump malfunctioned?

A. Have serviced by a Outboards dealer.

# Trouble Recovery

Q. Is load on boat improperly distributed?

A. Distribute load to place boat on an even plane.

Q. Is water pump or thermostat faulty?

A. Have serviced by a Outboards dealer.

Q. Is there excess water in fuel filter cup?

A. Drain filter cup.

## **Engine power loss.**

Q. Is propeller damaged?

A. Have propeller repaired or replaced.

Q. Is propeller pitch or diameter incorrect?

A. Install correct propeller to operate outboard at its recommended speed (r/min) range.

Q. Is trim angle incorrect?

A. Adjust trim angle to achieve most efficient operation.

Q. Is motor mounted at incorrect height on transom?

A. Have motor adjusted to proper transom height.

Q. Has alert system activated?

A. Find and correct cause of alert.

Q. Is boat bottom fouled with marine growth?

A. Clean boat bottom.

Q. Are spark plug(s) fouled or of incorrect type?

A. Inspect spark plug(s). Clean or replace with recommended type.

Q. Are weeds or other foreign matter tangled on gear housing?

A. Remove foreign matter and clean lower unit.

Q. Is fuel system obstructed?

A. Check for pinched or kinked fuel line or other obstructions in fuel system.

Q. Is fuel filter clogged?

A. Clean or replace filter.

Q. Is fuel contaminated or stale?

A. Fill tank with clean, fresh fuel.

Q. Is spark plug gap incorrect?

A. Inspect and adjust as specified.

Q. Is ignition wiring damaged or poorly connected?

A. Check wires for wear or breaks. Tighten all loose connections. Replace worn or broken wires.

Q. Have electrical parts failed?

A. Have serviced by a Outboards dealer.

Q. Is specified fuel not being used?

A. Replace fuel with specified type.

Q. Is specified engine oil not being used?

A. Check and replace oil with specified type.

Q. Is thermostat faulty or clogged?

A. Have serviced by a Outboards dealer.

Q. Is air vent screw closed?

A. Open the air vent screw.

Q. Is fuel pump damaged?

A. Have serviced by a Outboards dealer.

Q. Is fuel joint connection incorrect?

# Trouble Recovery

A. Connect correctly.

Q. Is heat range of spark plug incorrect?

A. Inspect spark plug and replace it with recommended type.

Q. Is high pressure fuel pump drive belt broken?

A. Have serviced by a Outboards dealer.

Q. Is engine not responding properly to shift lever position?

A. Have serviced by a Outboards dealer.

## **Engine vibrates excessively.**

Q. Is propeller damaged?

A. Have propeller repaired or replaced.

Q. Is propeller shaft damaged?

A. Have serviced by a Outboards dealer.

Q. Are weeds or other foreign matter tangled on propeller?

A. Remove and clean propeller.

Q. Is motor mounting bolt loose?

A. Tighten bolt.

Q. Is steering pivot loose or damaged?

A. Tighten or have serviced by a Outboards dealer.

## **Temporary action in emergency**

### **Impact damage**

**The outboard motor can be seriously damaged by a collision while operating or trailering. Damage could make the outboard motor unsafe to operate.**

If the outboard motor hits an object in the water, follow the procedure below.



1. Stop the engine immediately.
2. Check the control system and all components for damage. Also, check the boat for damage.
3. Whether damage is found or not, return to the nearest harbor slowly and carefully.
4. Have a Outboards dealer check the outboard motor before operating it again.

### **Replacing fuse**

If a fuse has blown, open the fuse holder and remove the fuse with a fuse puller. Replace it with a spare one of the proper amperage.

**Substituting an incorrect fuse or a piece of wire could allow excessive current flow. This could cause electric system damage and a fire hazard.**

Consult your Outboards dealer if the new fuse immediately blows again.

# Trouble Recovery

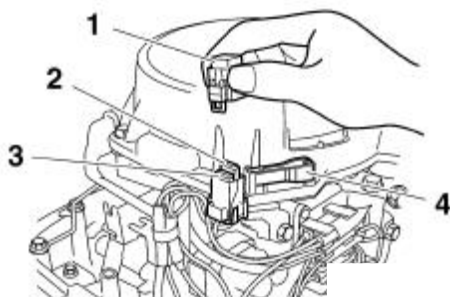

1. Fuse box
2. Fuse (10 A)
3. Spare fuse (10 A)
4. Fuse puller

## Power tilt will not operate

If the engine cannot be tilted up or down with the power tilt because of a discharged battery or a failure with the power tilt unit, the engine can be tilted manually.

1. Loosen the manual valve screw by turning it counterclockwise until it stops.

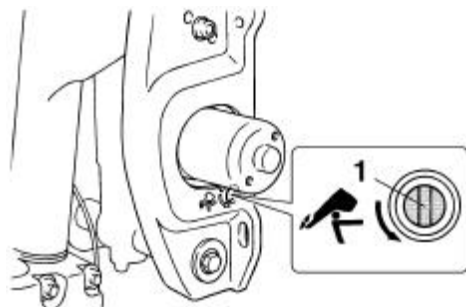

1. Manual valve screw
2. Put the engine in the desired position, then tighten the manual valve screw by turning it clockwise.

## Starter will not operate

If the starter mechanism does not operate (the engine cannot be cranked with the starter), the engine can be started with an emergency starter rope.

- ⚠ Use this procedure only in an emergency to return to the nearest port for repairs.
- ⚠ When the emergency starter rope is used to start the engine, the start-in-gear protection device does not operate. Make sure the remote control lever is in neutral. Otherwise the boat could unexpectedly start to move, which could result in an accident.
- ⚠ Attach the engine shut-off cord to a secure place on your clothing, or your arm or leg while operating the boat.
- ⚠ Do not attach the cord to clothing that could tear loose. Do not route the cord where it could become entangled, preventing it from functioning.
- ⚠ Avoid accidentally pulling the cord during normal operation. Loss of engine power means the loss of most steering control. Also, without engine power, the boat could slow rapidly. This could cause people and objects in the boat to be thrown forward.
- ⚠ Make sure no one is standing behind you when pulling the starter rope. It could whip behind you and injure someone.
- ⚠ An unguarded, rotating flywheel is very dangerous. Keep loose clothing and other objects away when starting the engine. Use the emergency starter rope only as instructed. Do not touch the flywheel or other moving parts when the engine is running. Do not install the starter mechanism or top cowling after the engine is running.

# Trouble Recovery

⚠ Do not touch the ignition coil, spark plug wire, spark plug cap, or other electrical components when starting or operating the motor. You could get an electrical shock.

## Emergency starting engine

1. Remove the top cowling.
2. Remove the start-in-gear protection cable from the starter, if equipped.

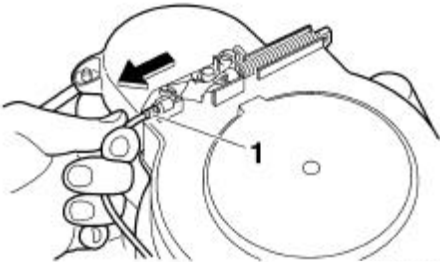

1. Start-in-gear protection cable
3. Remove the starter/flywheel cover after removing the bolt(s).

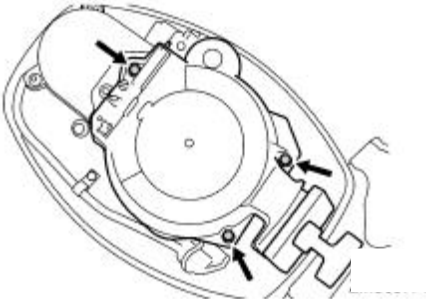

4. Prepare the engine for starting. For further information, see page 38. Be sure the engine is in neutral and that the clip is attached to the engine shut-off switch. The main switch must be "ON" (on), if equipped.

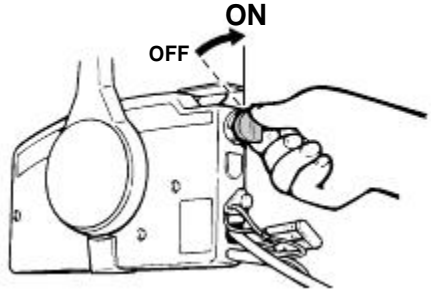

5. If equipped the choke knob, pull out it when the engine is cold. After the engine starts, gradually return the choke knob to its home position as the engine warms up.



6. Insert the knotted end of the emergency starter rope into the notch in the flywheel rotor and wind the rope several turns around the flywheel clockwise.
7. Give a strong pull straight out to crank and start the engine. Repeat if necessary.



# Trouble Recovery

ly. **NOTICE:** Do not attempt to run the outboard motor until it has been completely inspected.

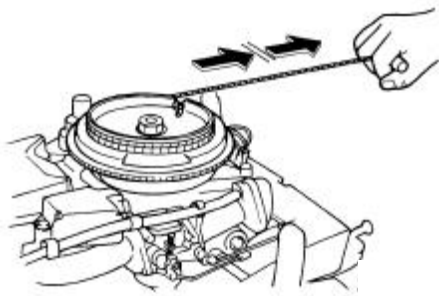

## Engine fails to operate

### Emergency engine operation

If the battery voltage is low or in the unlikely event of an ignition system malfunction, the engine speed may become erratic or the engine may stop. In such a situation, follow the procedure below.

Disconnect the yellow cord (emergency circuit) of the CDI unit.

Run the engine at low speed and return to port. **NOTICE:** Follow this procedure only in an emergency and just long enough to return to port for repairs.

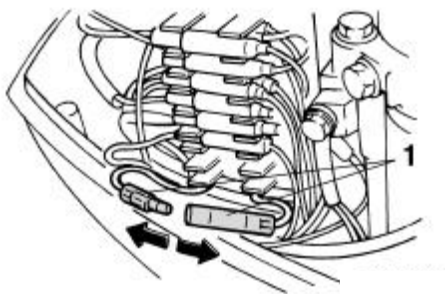

1. Yellow cord

### Treatment of submerged motor

If the outboard motor is submerged, immediately take it to a Outboards dealer. Otherwise some corrosion may begin almost immediate-

